

Пользователь /Username radugaa  
Дата / Date 03.06.2019 15:51:49  
Имя файла / Filename Платье рубашка с капюшоном 40-52  
Формат / Format A4  
Кол-во листов / Pages 27

[Дизайн|Пошив|Мастер-классы|Выкройки](#)

[https://vk.com/dressmaking\\_courses](https://vk.com/dressmaking_courses)

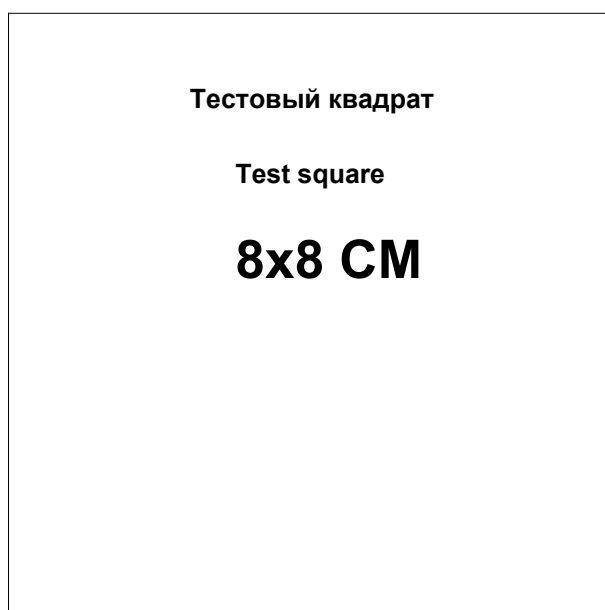

## **ВАЖНО**

При печати этого PDF файла «Масштабирование страницы» или «Page scaling»  
должно быть равно «Нет» или «No»

Печать производите в «Истинный размер» или «Actual size»

Подробнее смотрите в разделе «Помощь» - «Печать PDF файлов»

1:1

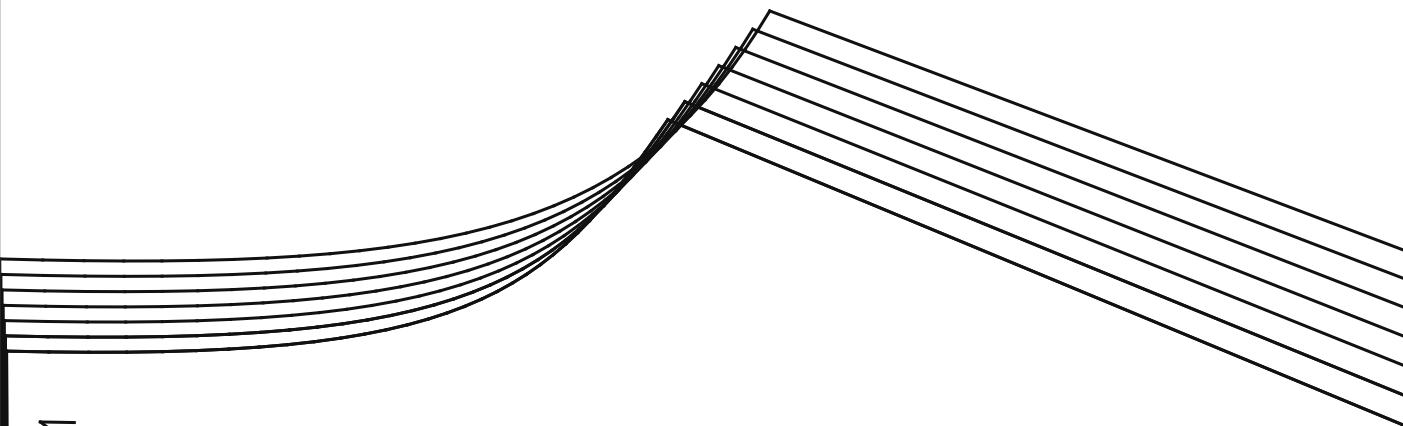

ЗАЛНЧЯ СЕРЕДИНА ДОЛЕВАЯ НИТЬ СГИБ ТКАНИ

2:1  
↓

→  
1:2

1:2

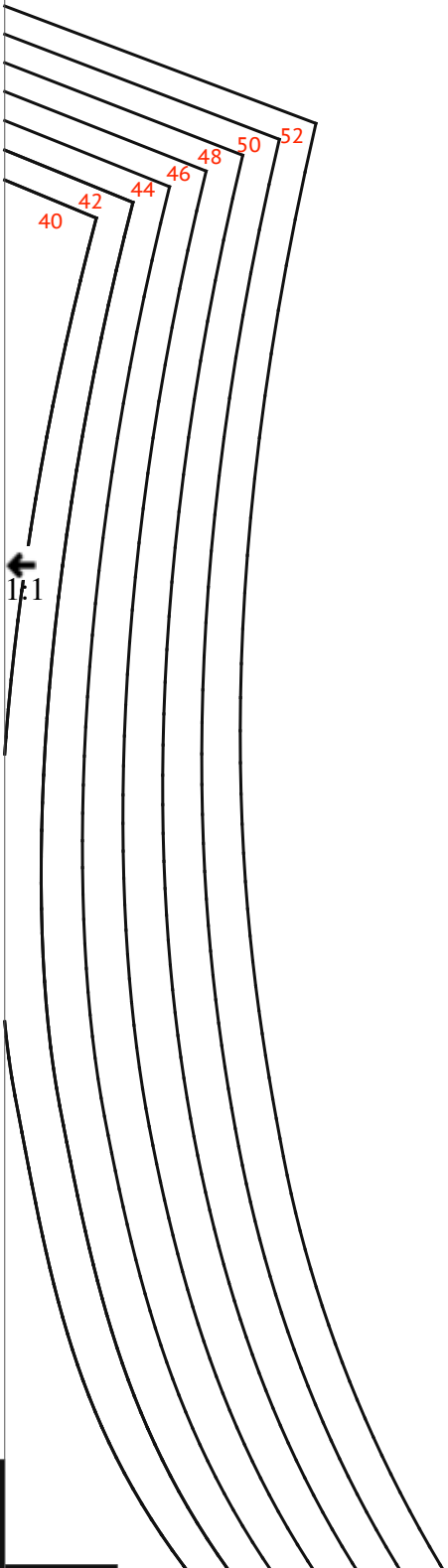

←  
1:1

→  
1:3

2:2  
↓

1:3

←  
1:2

→  
1:4

↓  
2:3

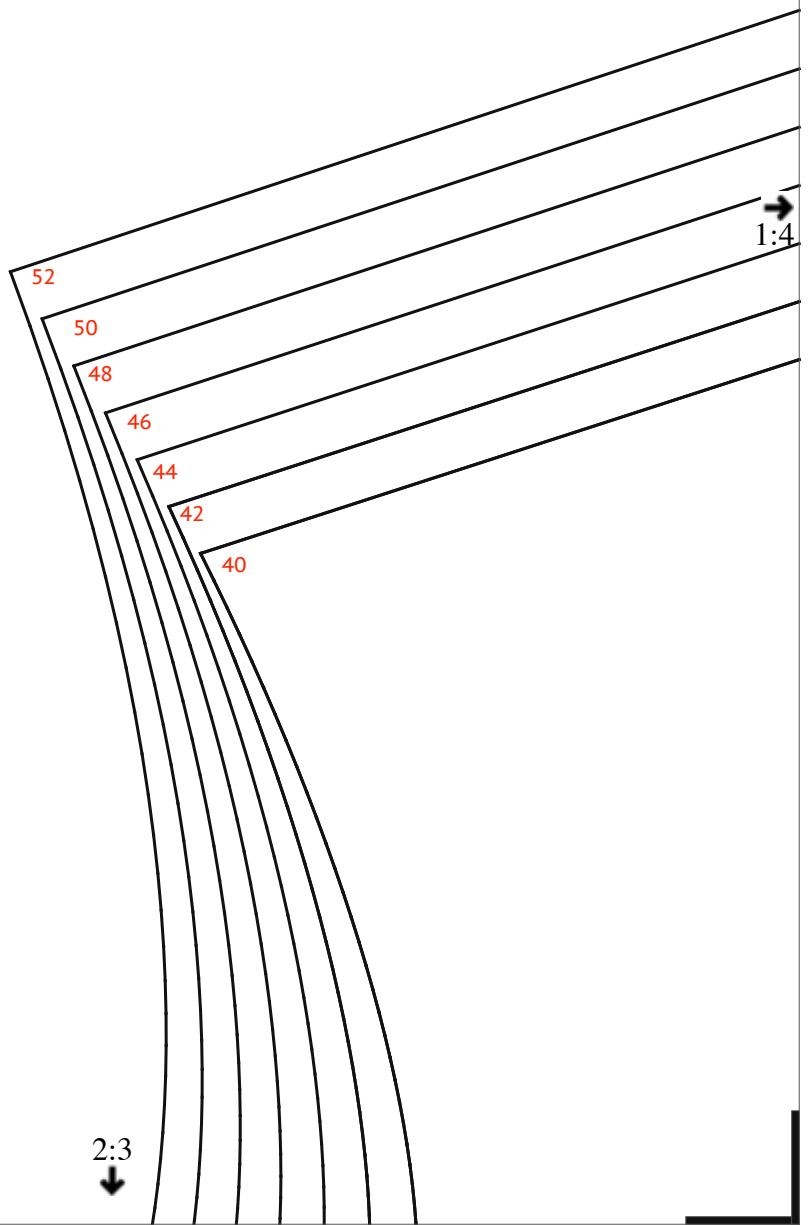

1:4

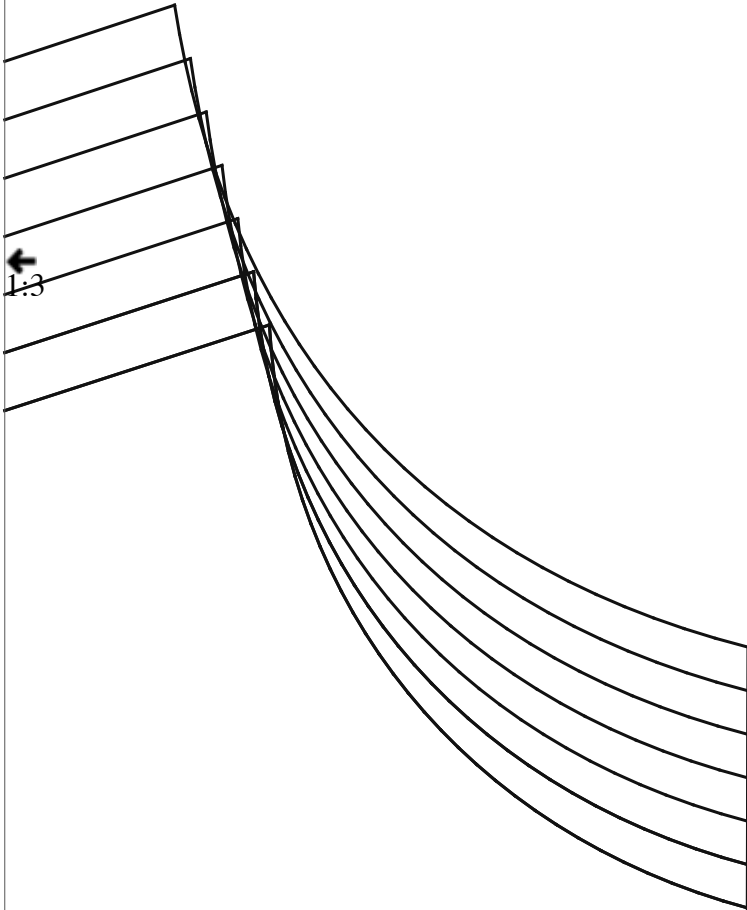

←  
1:3

2:4  
↓

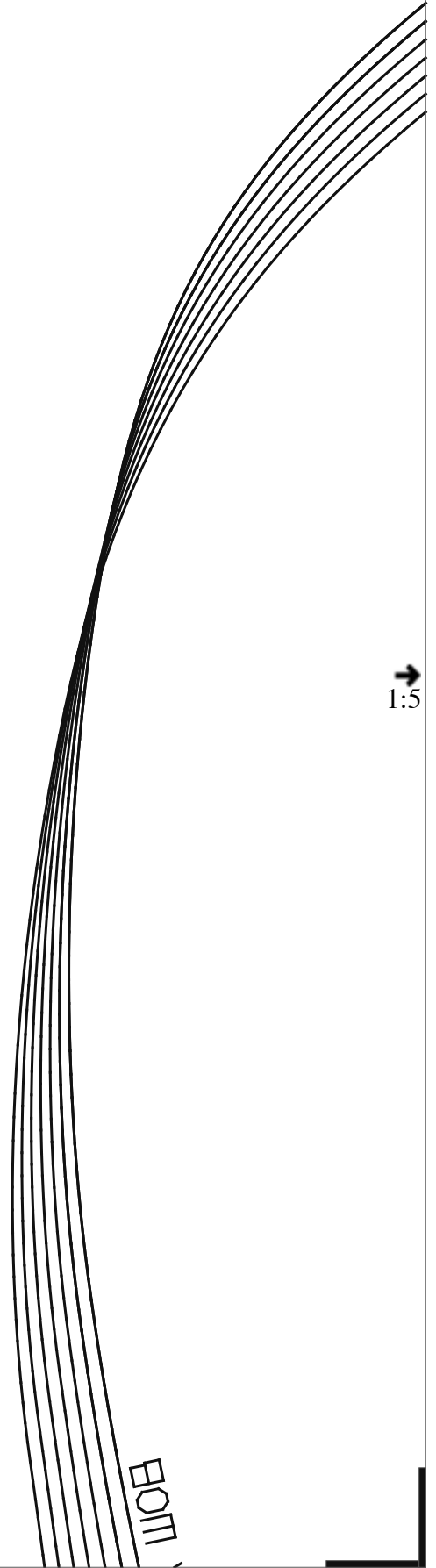

→  
1:5

BOOM

1:5

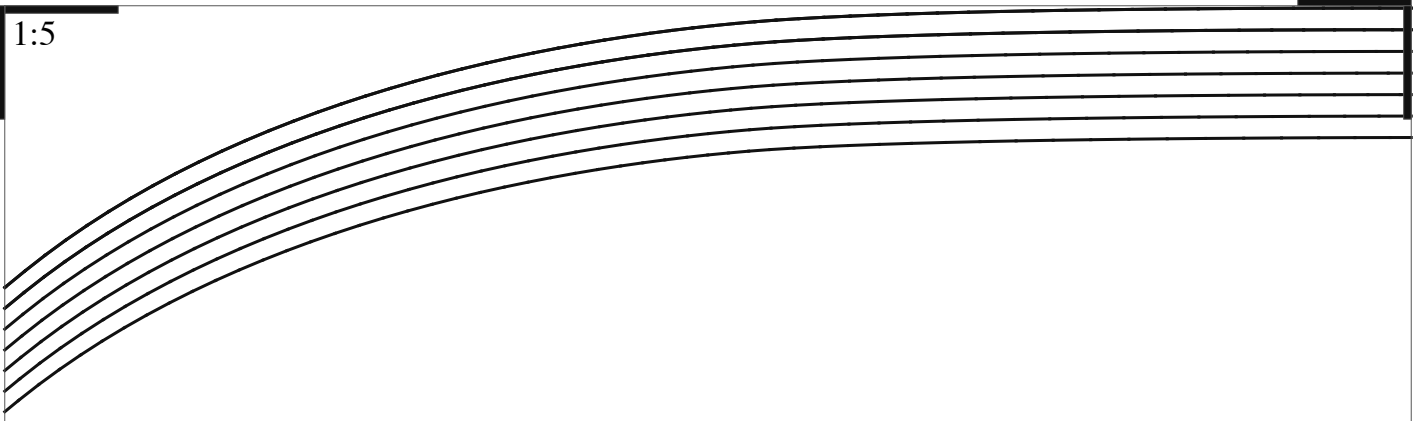

←  
1:4

→  
1:6

↓  
2:5

1:6

←  
1:5

ОБТАЧКА, ПОДБОРТ СГИБ

ДОЛБЕВАЯ НИТЬ

↓  
2:6

→  
1:7

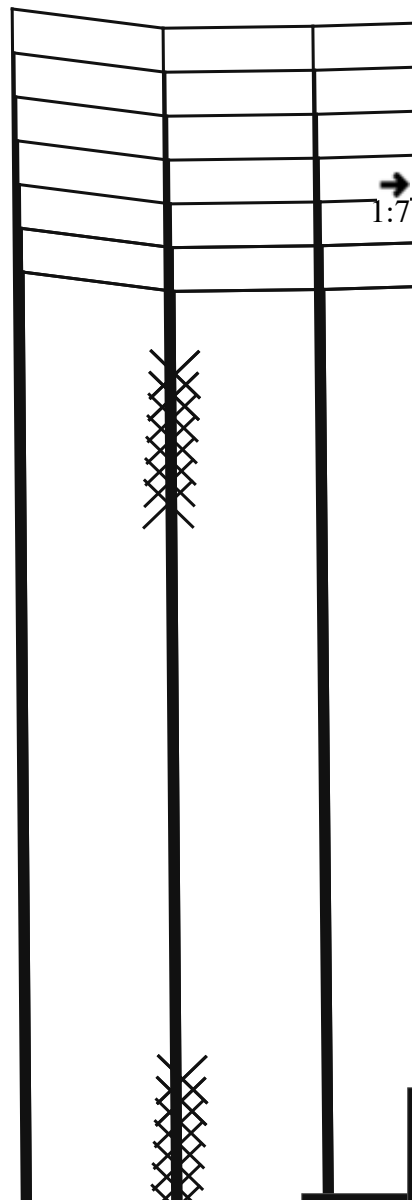

1:7

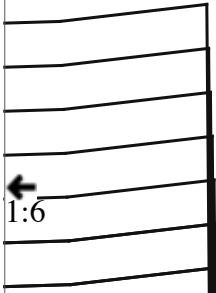

1:6

ПЛИНТ

2:7  
↓



2:1

1:1  
↑

→  
2:2

ТАЛИЯ

КУЛИКА

3:1  
↓

2:2

1:2



2:1



2:3

3:2

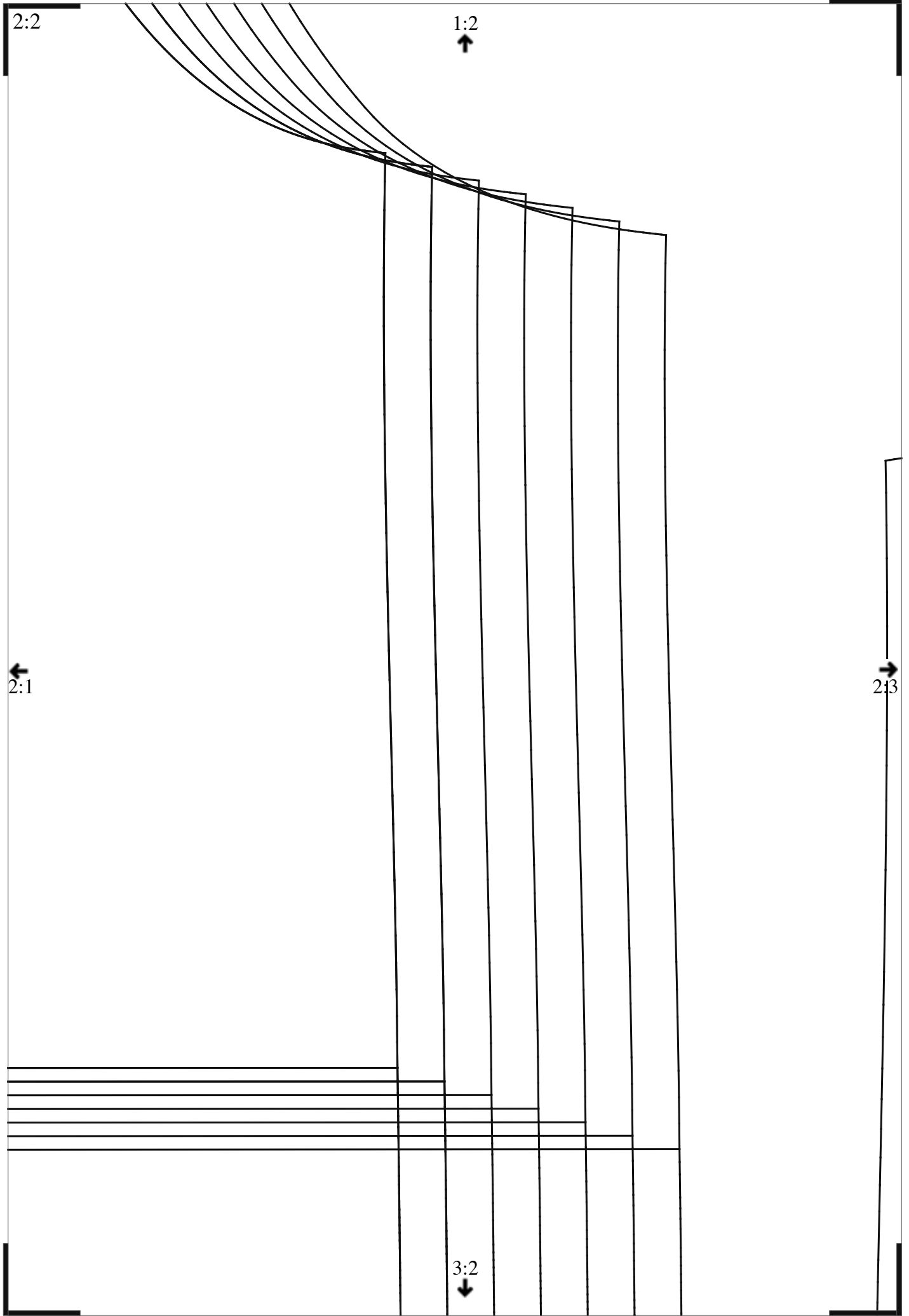

2:3

1:3



2:2

2:4

3:3

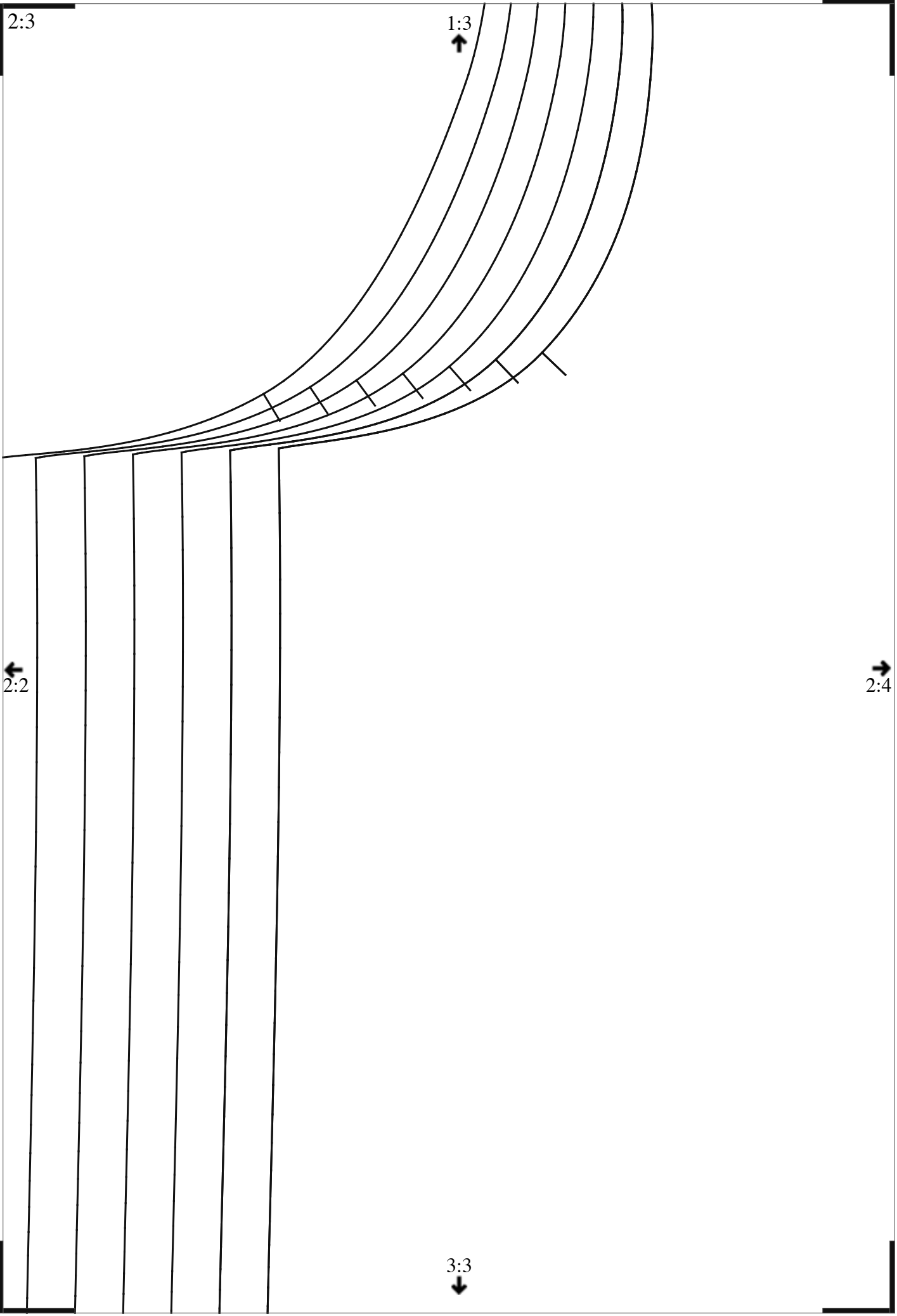

2:4

1:4

←  
2:3

ЛИНИЯ ШВА ПРИТАЧИВАНИЯ ПЛАНКИ, БЕЙКИ, КАНТА

3:4

→  
2:5

ЗАДНЯЯ СЕРЕДИНА

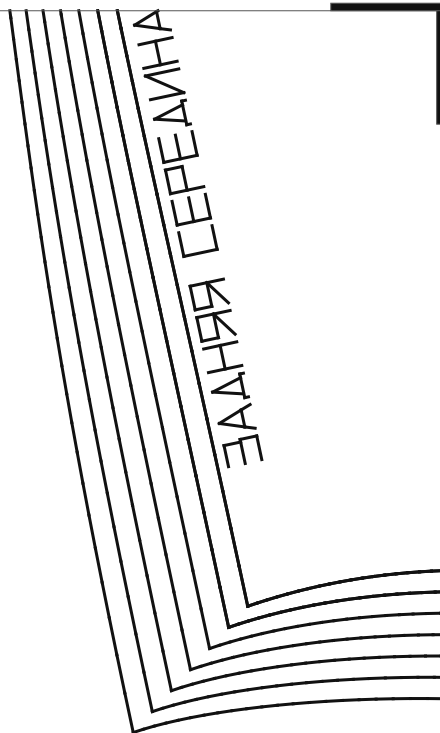

2:5

1

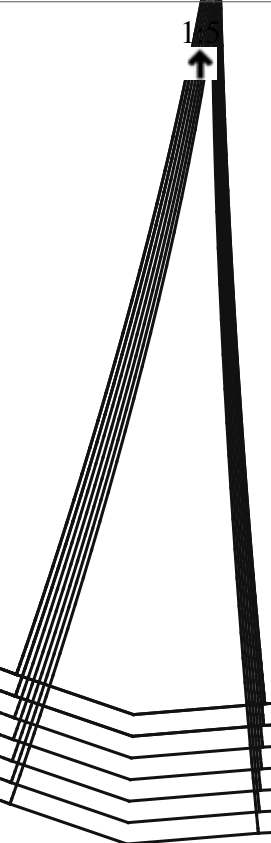
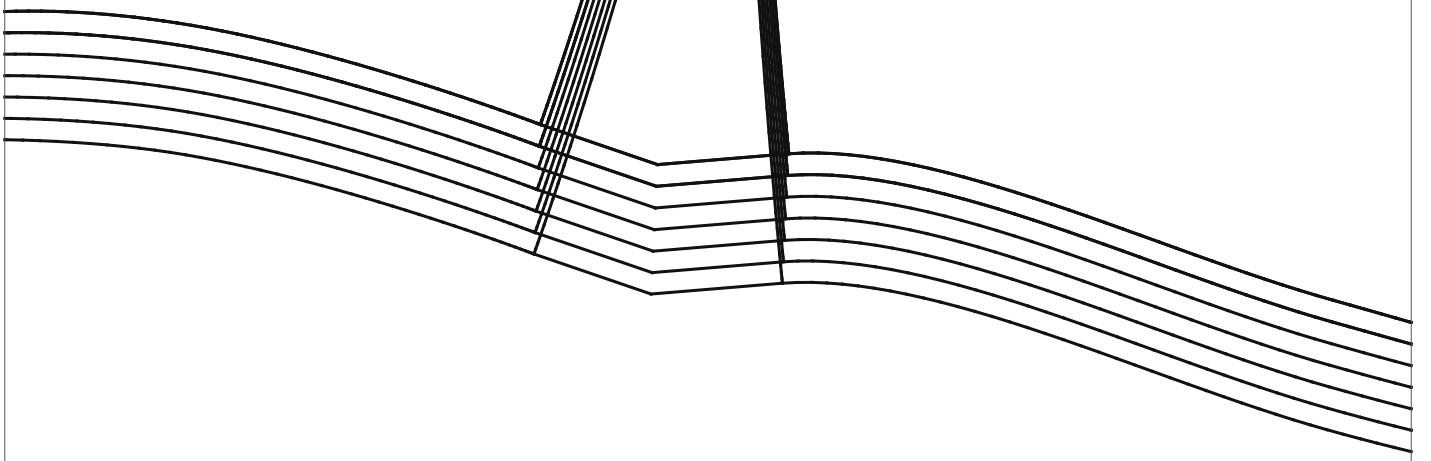

2:4



2:6

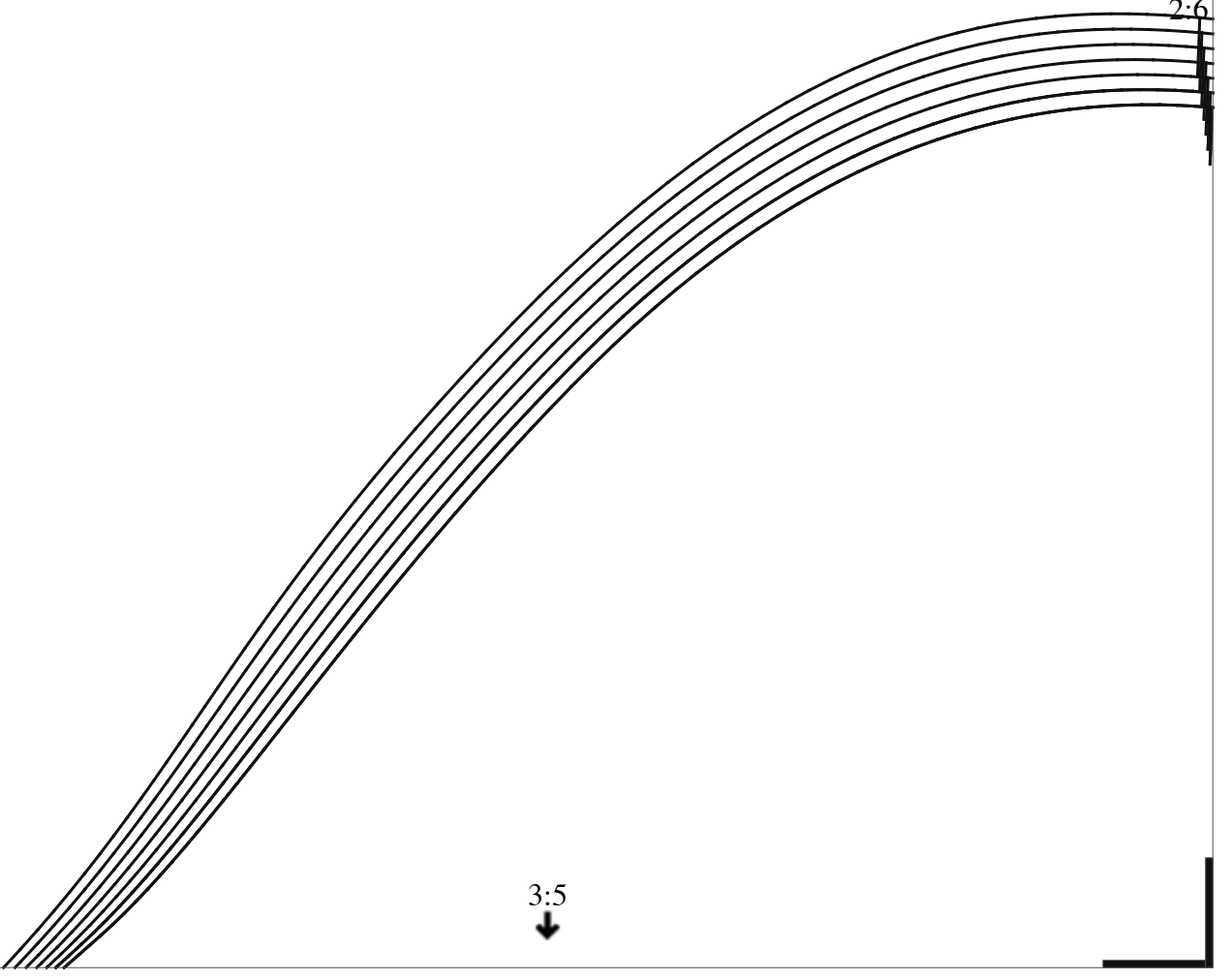

3:5



2:6

1:6  
↑

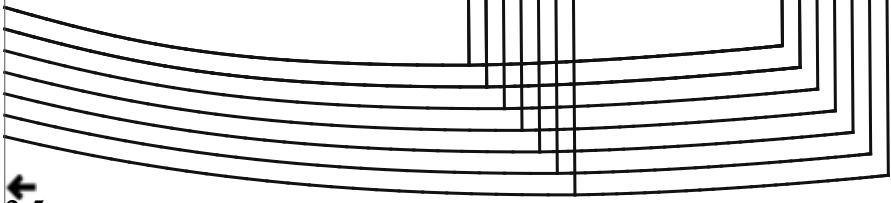

2:5  
←

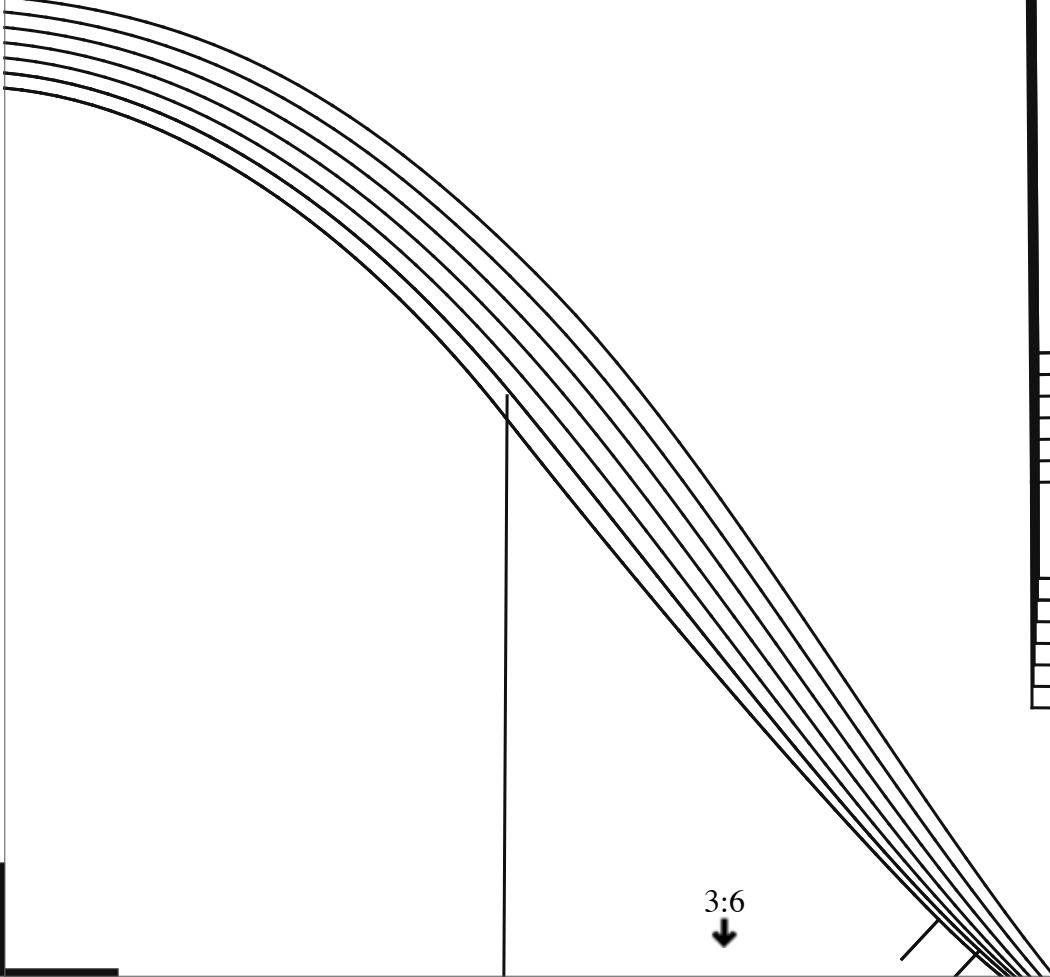

3:6  
↓

↑

ЛИНИЯ СЕРЕДИНЫ ПЕРЕДА

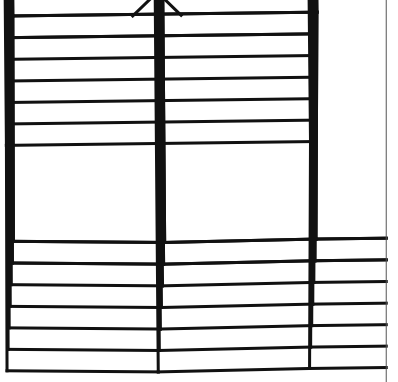

2:7  
→

ЛИНИЯ

2:7

AOAE

1:7  
↑

←  
2:6

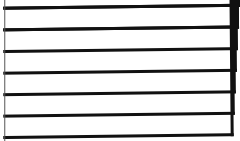

3:7  
↓

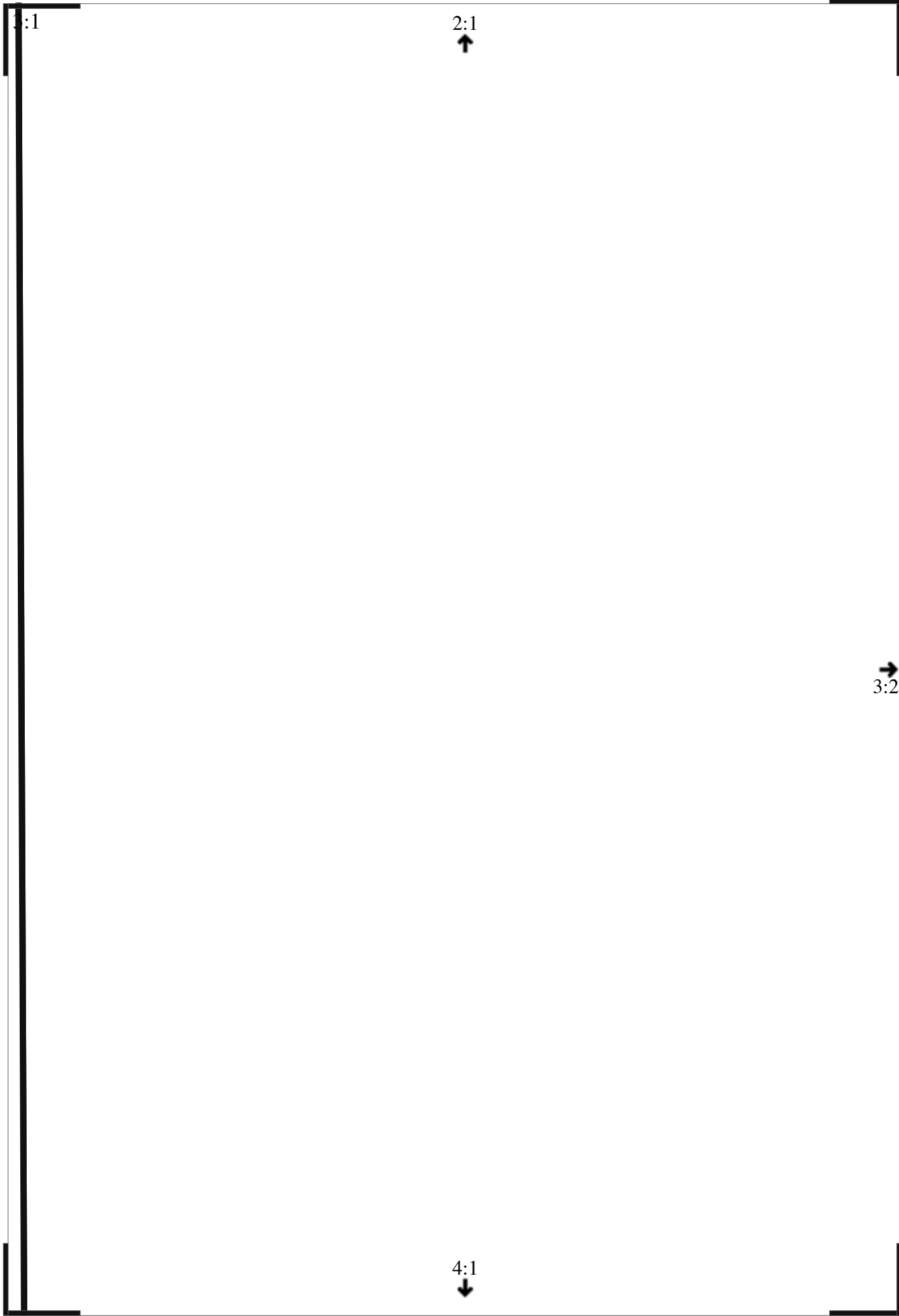



3:2

2:2



←  
3:1

→  
3:3

4:2

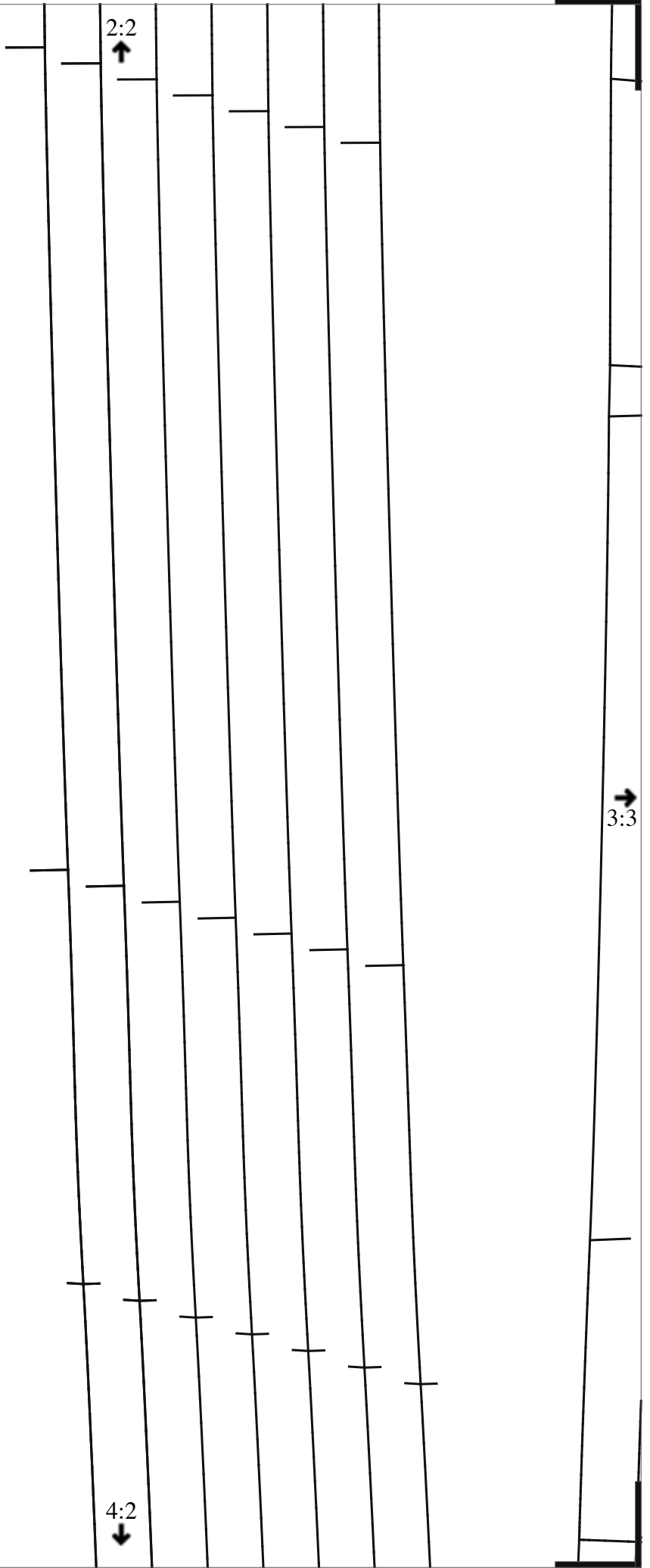

3:3

2:3  
↑

КУАД  

МЕШКОВИНА КАРМАНА

ВХОД В КАРМАН

←  
3:2

→  
3:4

4:3  
↓

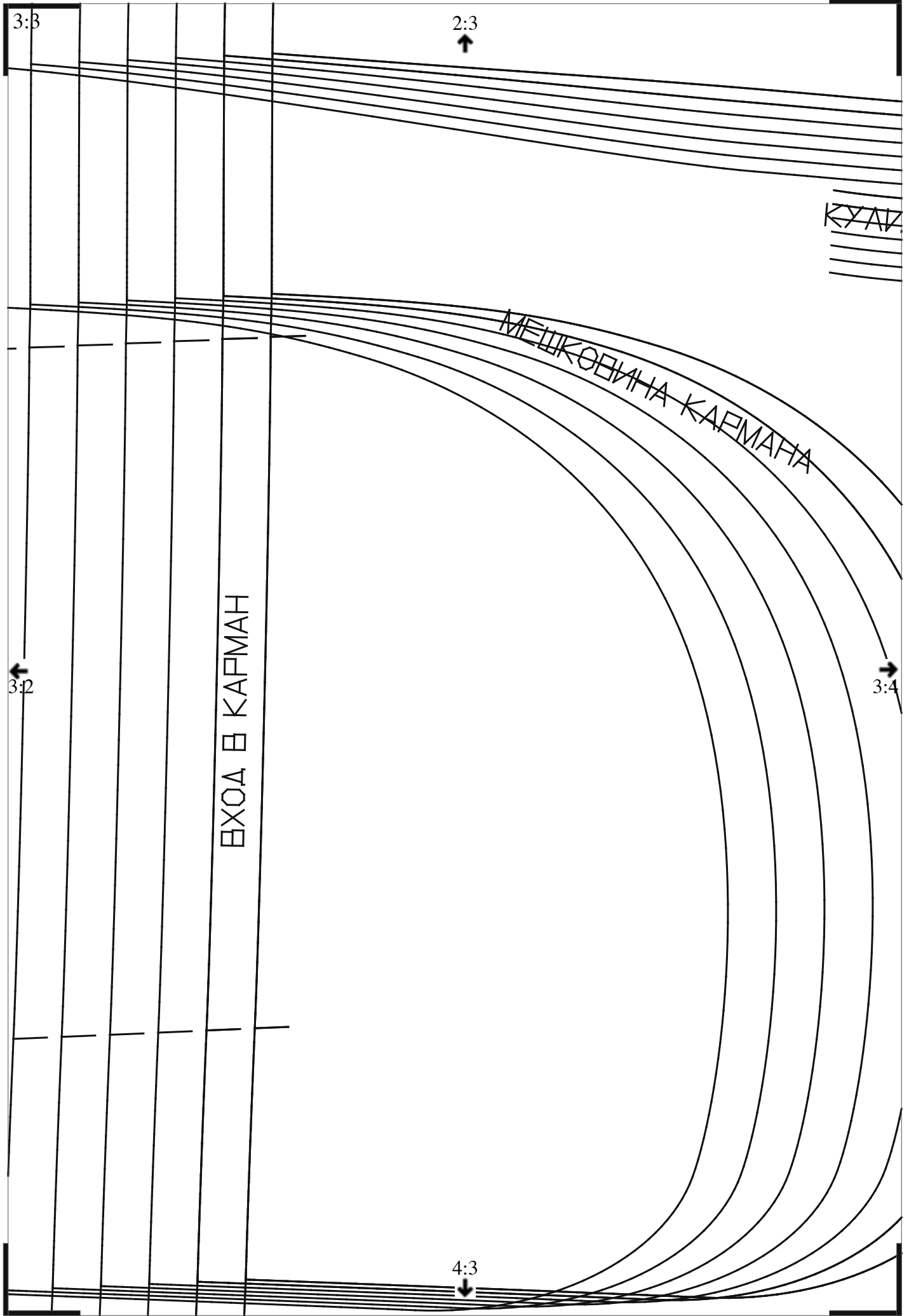

3:4

ЕКА

ШИЦА, РАБРЕЗ

2:4

ТАЛИЯ

3:3

4:4

СГИБ ДОЛЕВАЯ НИТЬ

3:5

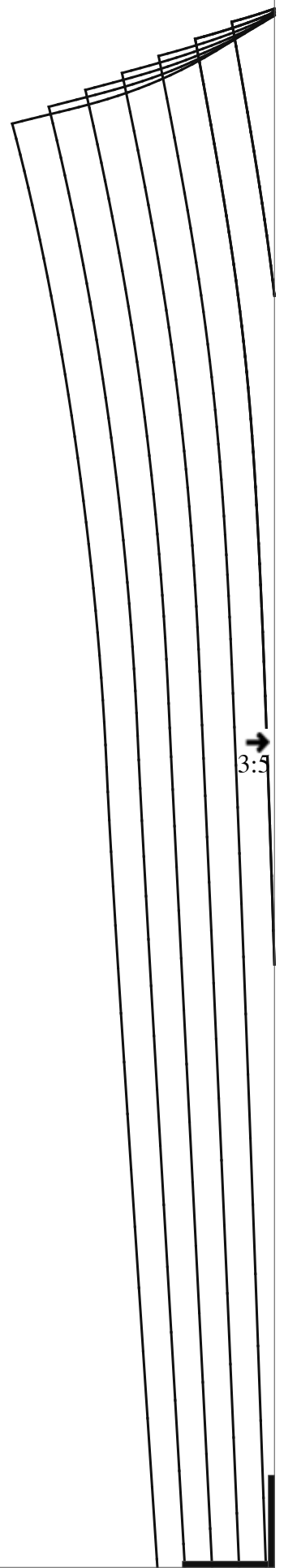
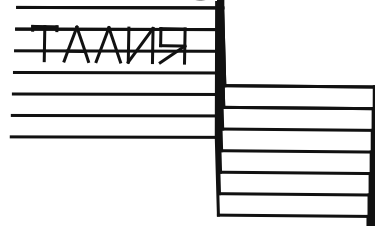
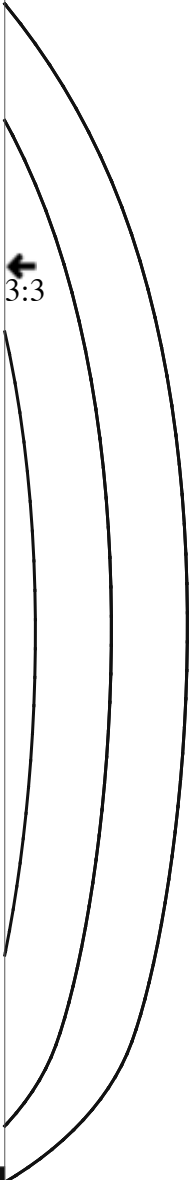

3:5

2:5



3:4

3:6

4:5

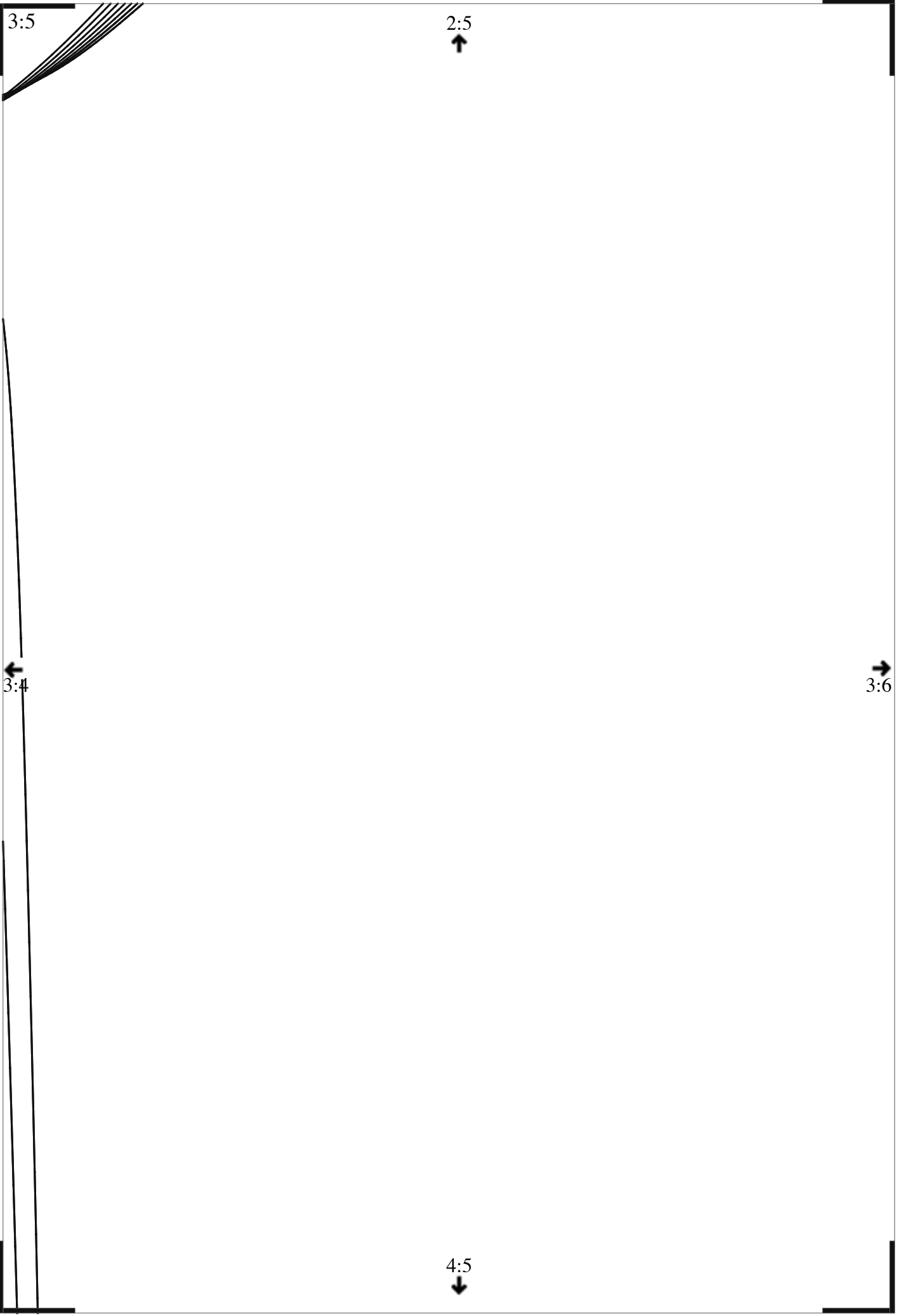

3:6

2:6  
↑

←  
3:5

→  
3:7

ДОЛЕВАЯ НИТЬ

4:6  
↓

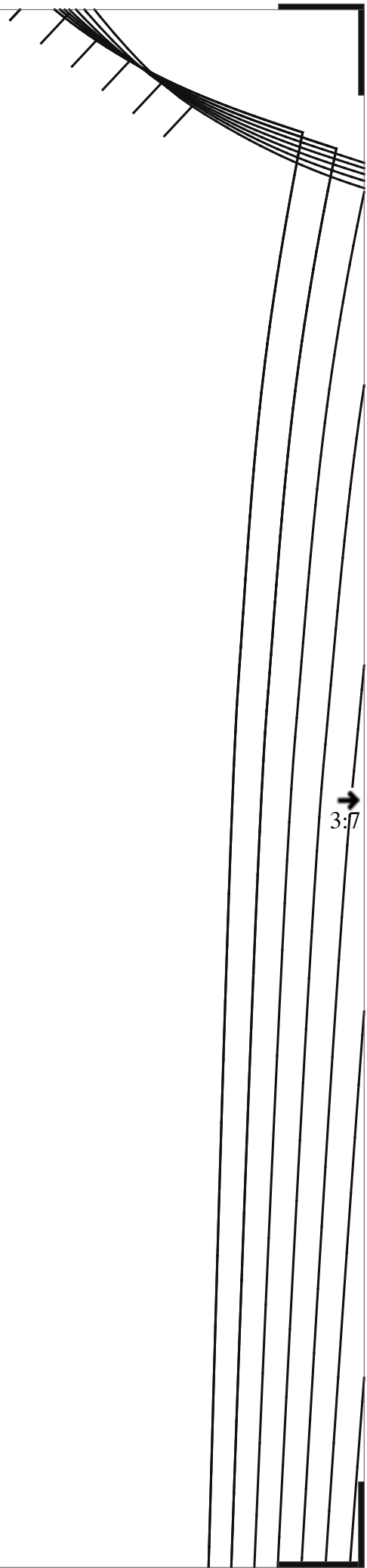

3:7

2:7  
↑

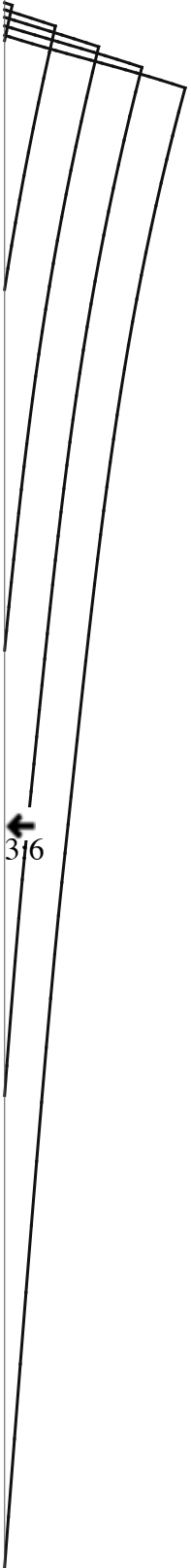

←  
316

4:1

3:1  
↑

→  
4:2

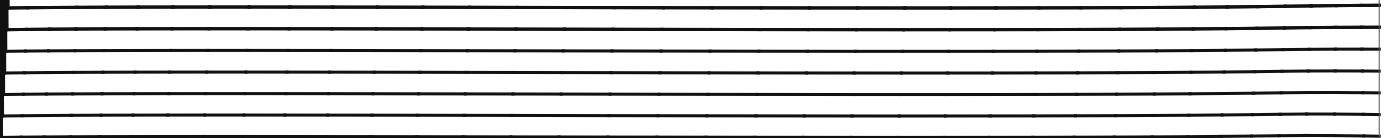

4:2

3:2  
↑

←  
4:1

→  
4:3

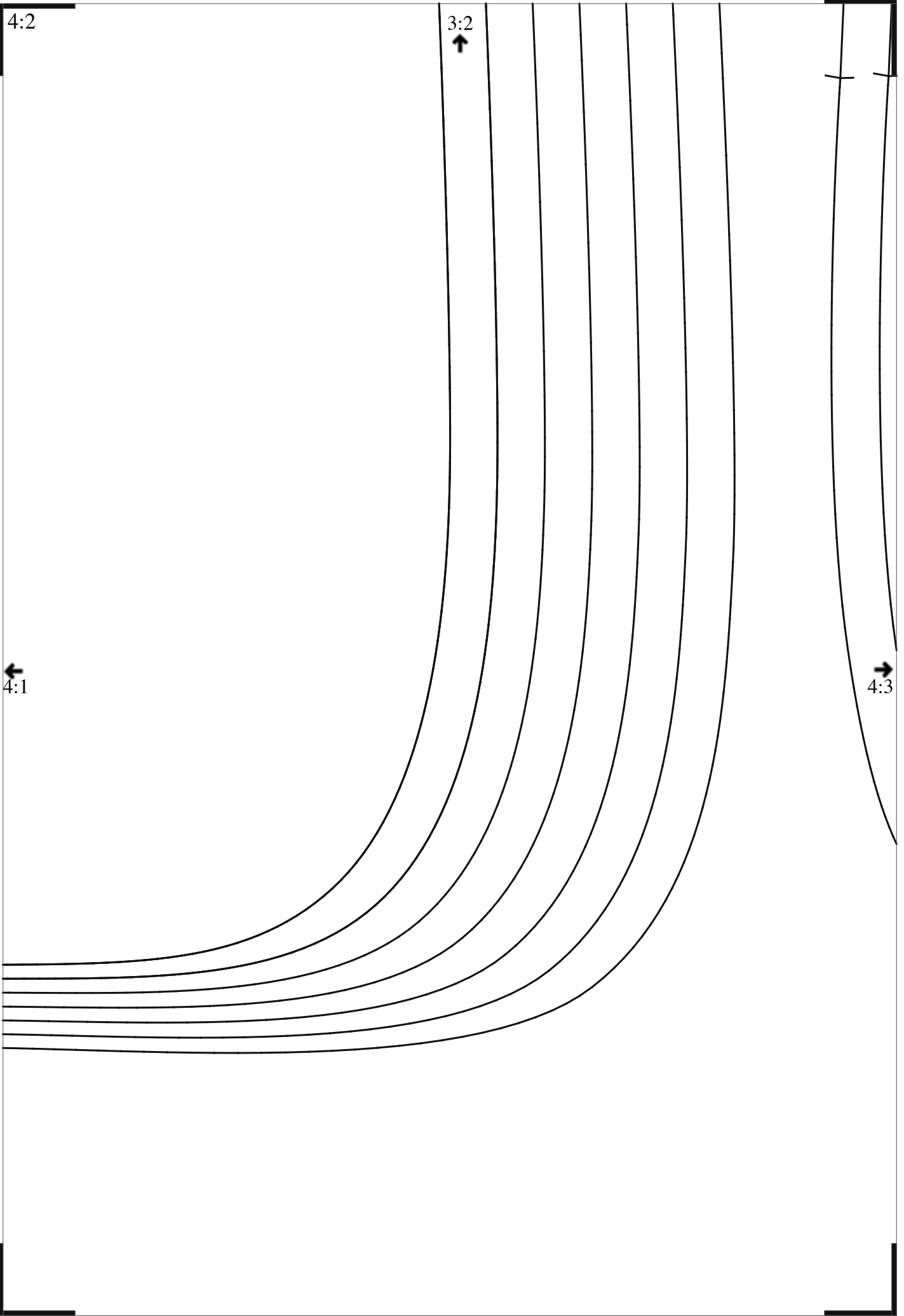



4:3

3:3



ШИЦА, РАЗРЕЗ

4:2

4:4

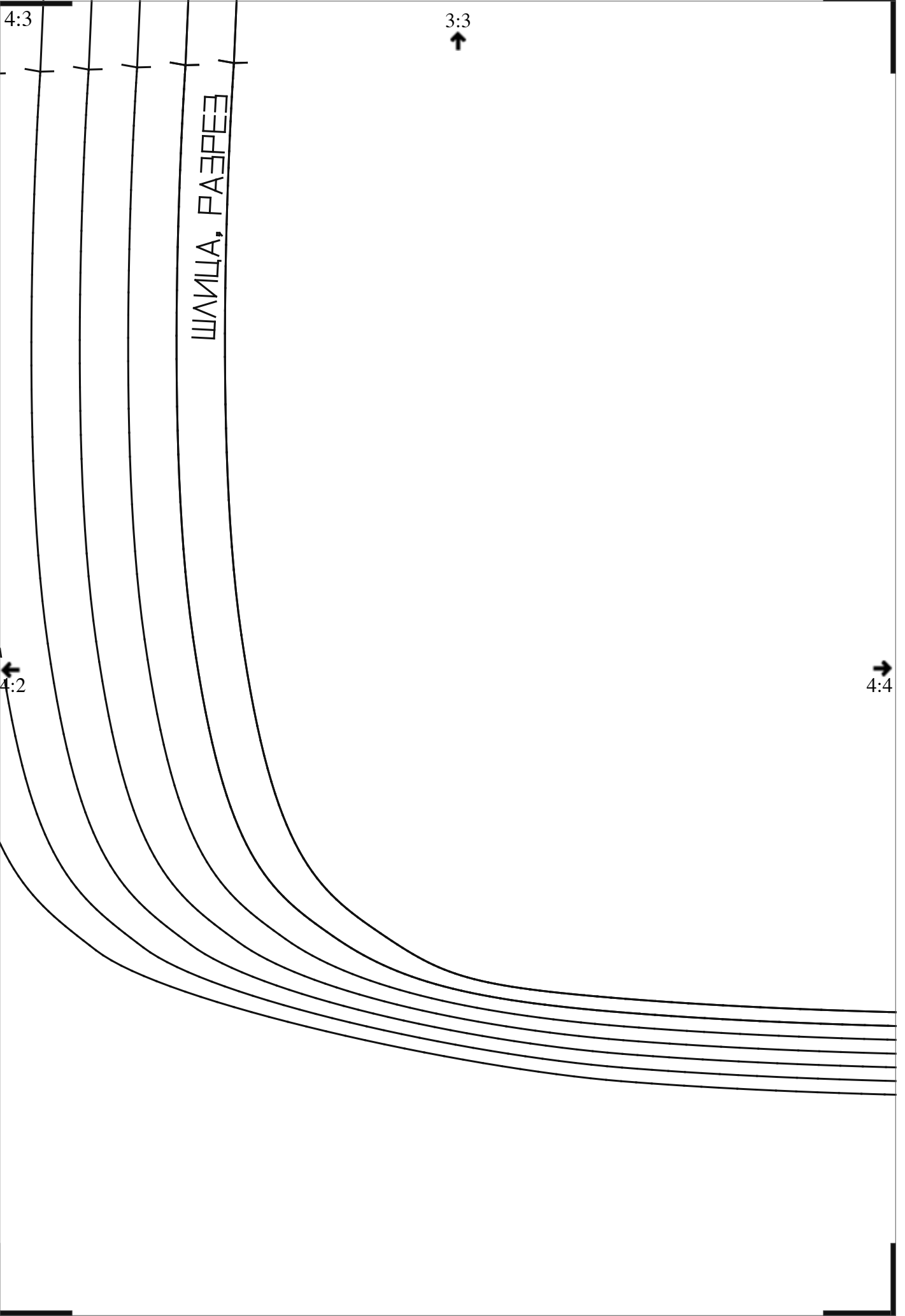

4:4

3:4  
↑

ЛИНИЯ СЕРЕДИНЫ ПЕРЕДА

←  
4:3

→  
4:5

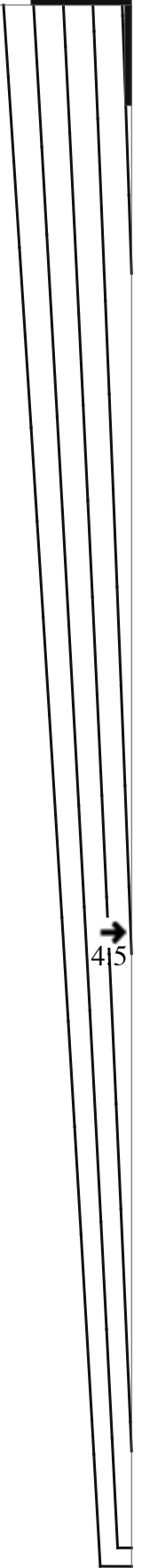
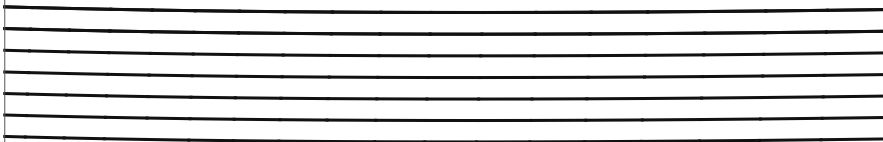

4:5

3:5



←  
4:4

→  
4:6

4:6

3:6  
↑



←  
4:5

КУЛИКА

