

ID: TEST10X10CM
SIZE: 38 WIERSZ 1 KOLUMNA 1
ROW 1 COLUMN 1

WIERSZ 2 KOLUMNA 1
ROW 2 COLUMN 1

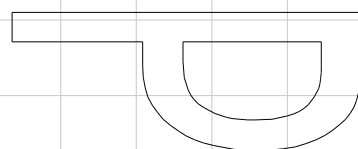
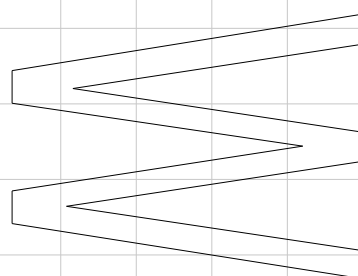
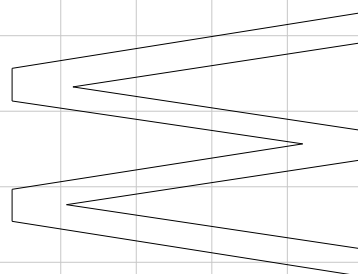
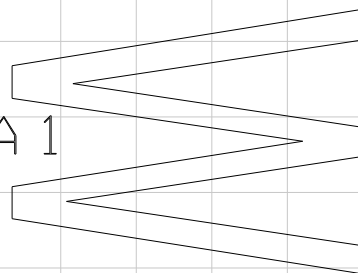

CTC

WI ERSZ 3 KOLUMNA 1
ROW 3 COLUMN 1

A

P

A

V

M

R

O

.

[

□
□

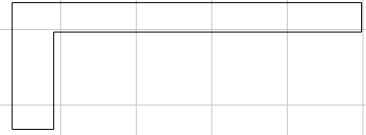
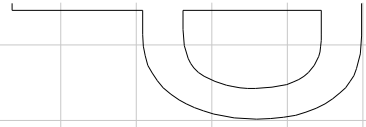

WI ERSZ 4 KOLUMNA 1

ROW 4 COLUMN 1

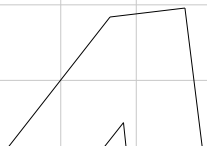

WI ERSZ 5 KOLUMNA 1
ROW 5 COLUMN 1

W
W
W
W
P
A

SIZE: 100
RE

H

SKAW/SLEEVEW-PCZ-14-02

PAVEPO.PL

WIERSZ 6 KOLUMNA 1
ROW 6 COLUMN 1

H

WI ERSZ 1 KOLUMNA 2

ROW 1 COLUMN 2

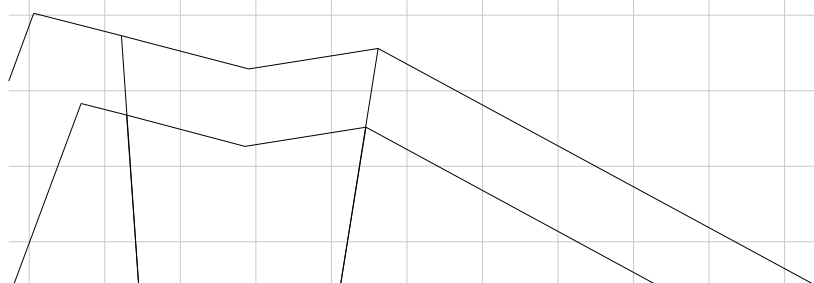

WIERSZ 2 KOLUMNA 2
ROW 2 COLUMN 2

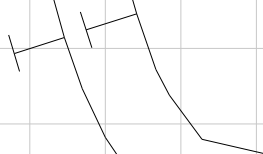
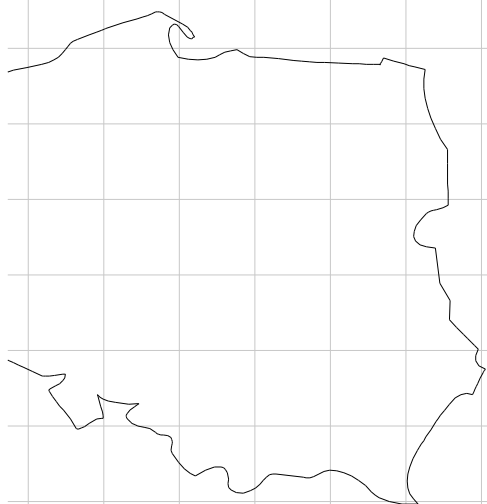
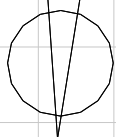

IP: 7E

PRZOD / FRONT W. PCZ. 14-02

WIERSZ 3 KOLUMNA 2
ROW 3 COLUMN 2

I I

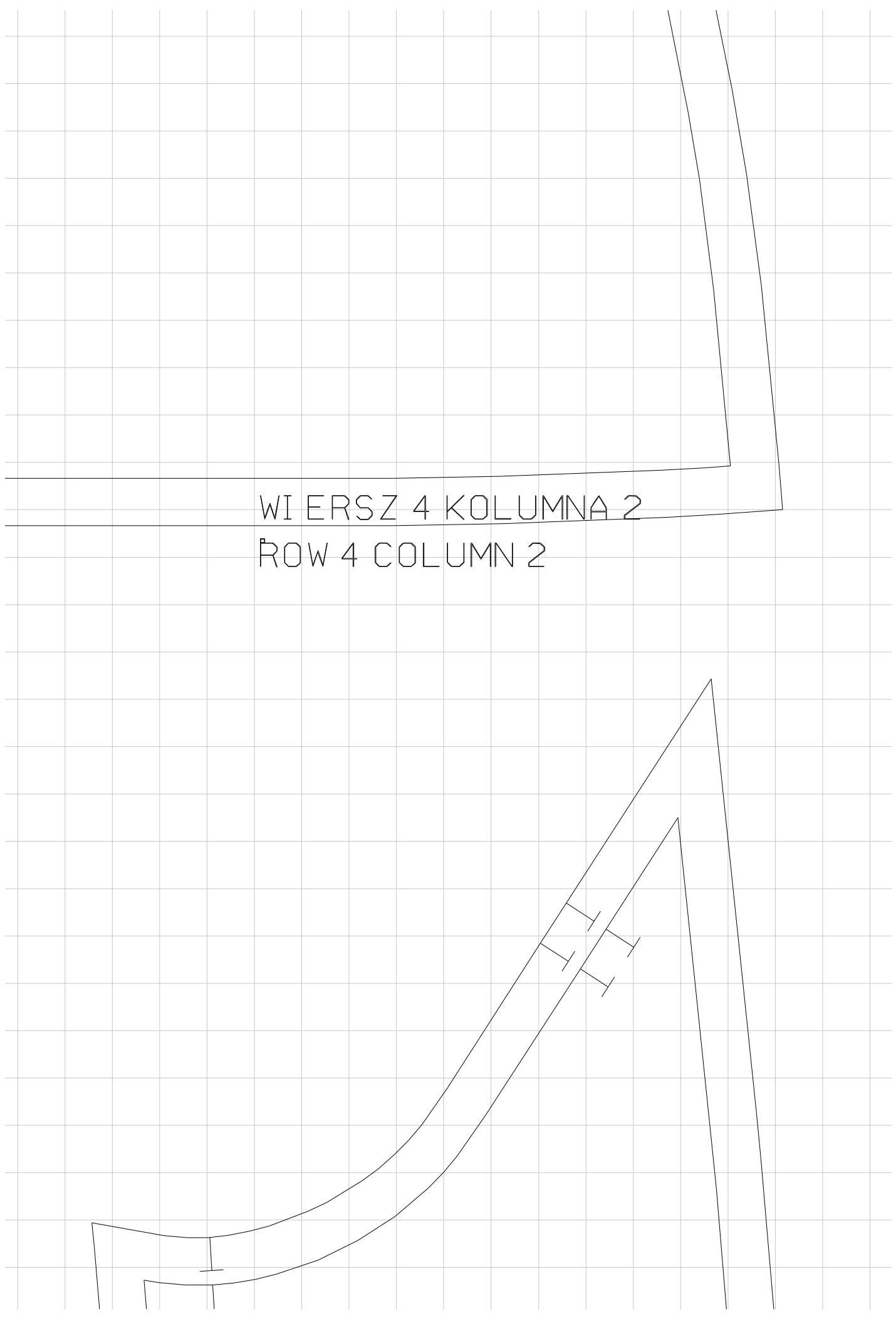

WIERSZ 4 KOLUMNA 2

ROW 4 COLUMN 2

W

W

W

P

A

P

A

E

DIZEE 38 REKAW/SLEEVE

~~WIERSZ 5 KOLUMNA 2~~
~~ROW 5 COLUMN 2~~

W_PCZ-14-

RO-P

]

WIERSZ 6 KOLUMNA 2
ROW 6 COLUMN 2

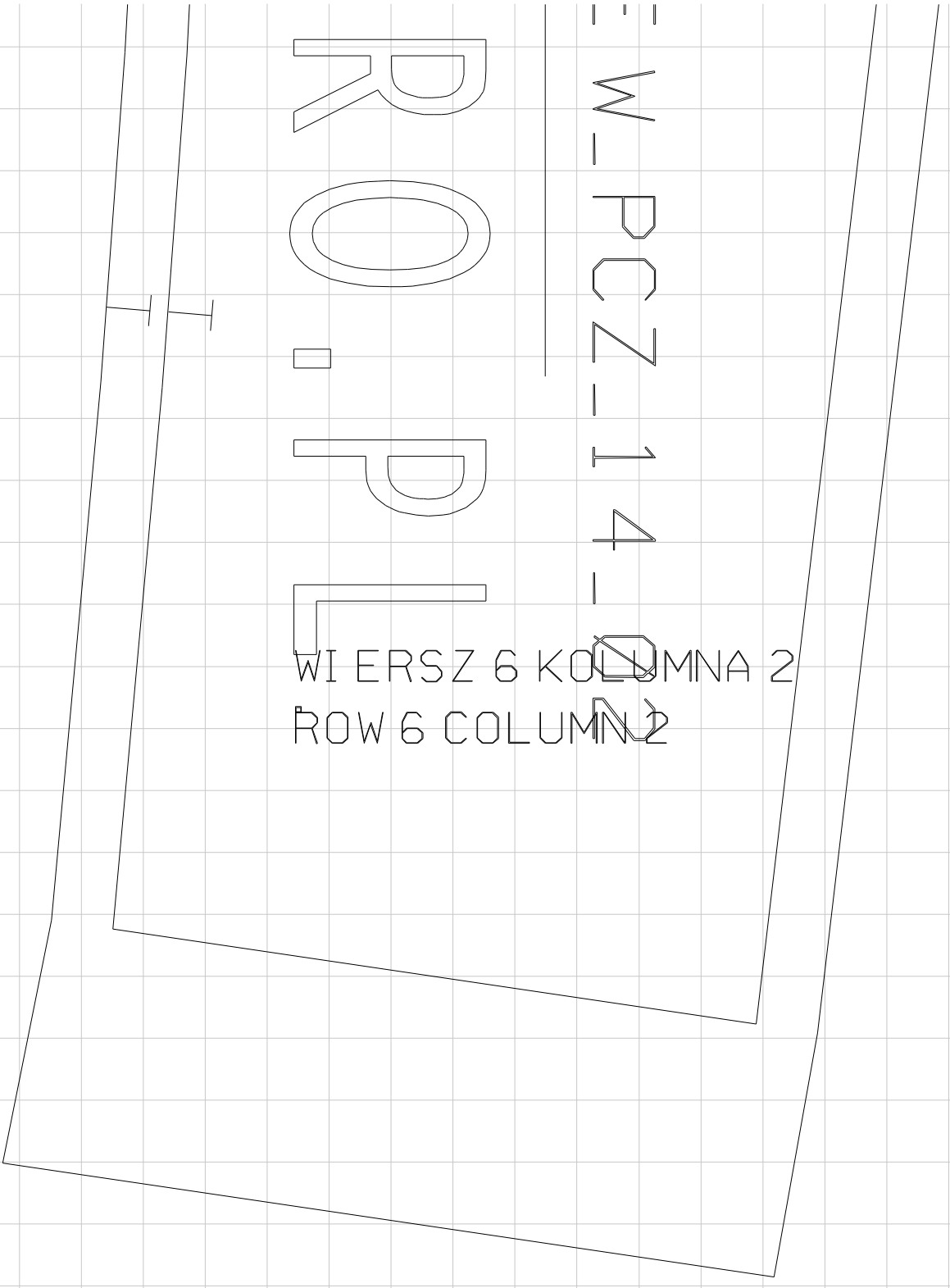

WIERSZ 1 KOLUMNA 3
ROW 1 COLUMN 3

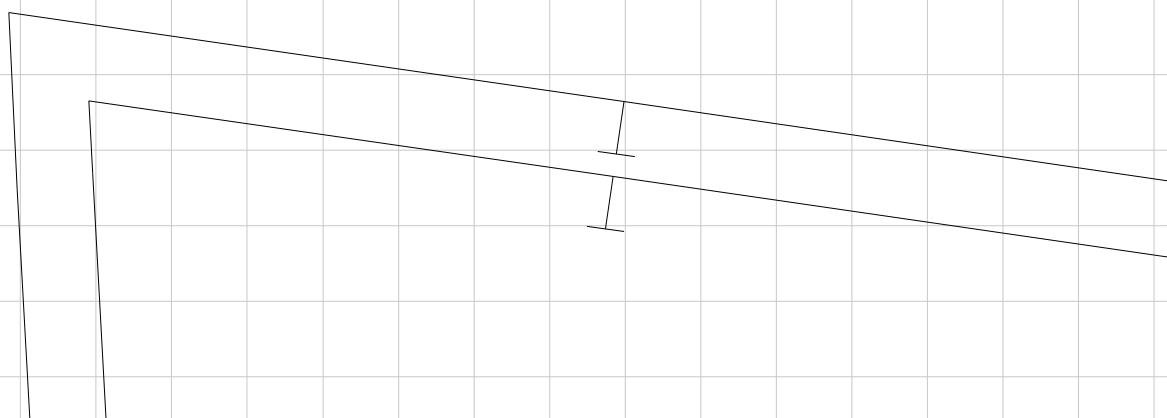

W

W

W

.

P

A

P

WIERSZ 2 KOLUMNA 3
ROW 2 COLUMN 3

LISTA PRZ
SIZ: 38

00 / FRONT W_P CZ_14_02

AA

E

R

O

.

P

L

WIERSZ 3 KOLUMNA 3
ROW 3 COLUMN 3

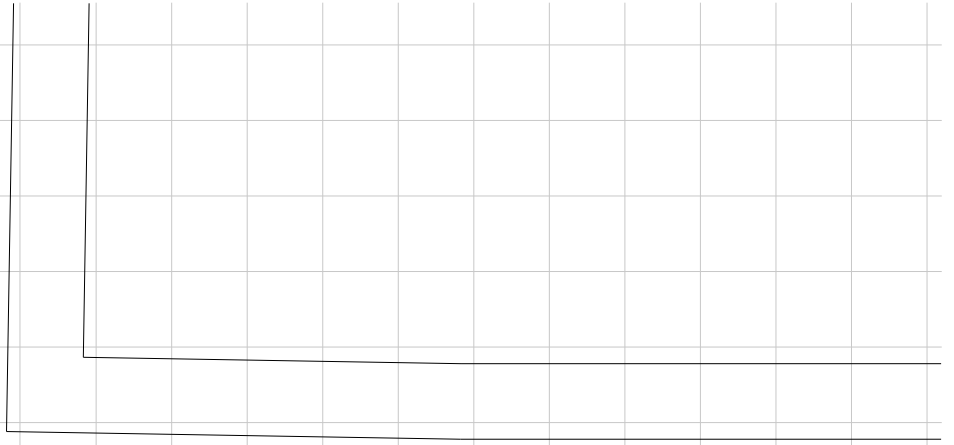

WIERSZ 4 KOLUMNA 3
ROW 4 COLUMN 3

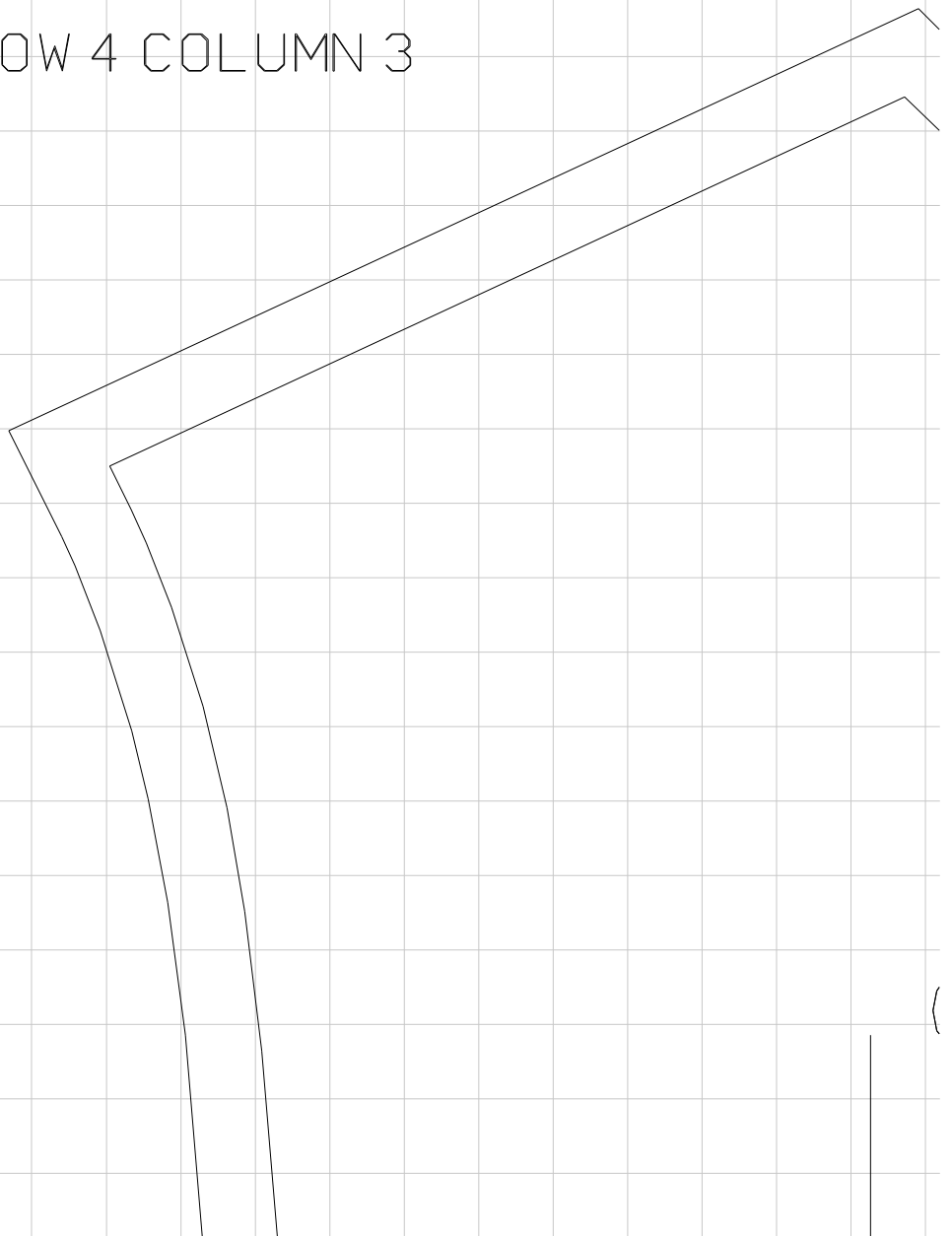

WI ERSZ 5 KOLUMNA 3
ROW 5 COLUMN 3

ST
Z
E
3
8

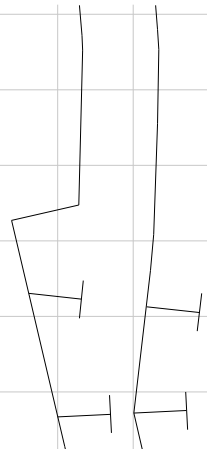

WIERSZ 6 KOLUMNA 3
ROW 6 COLUMN 3

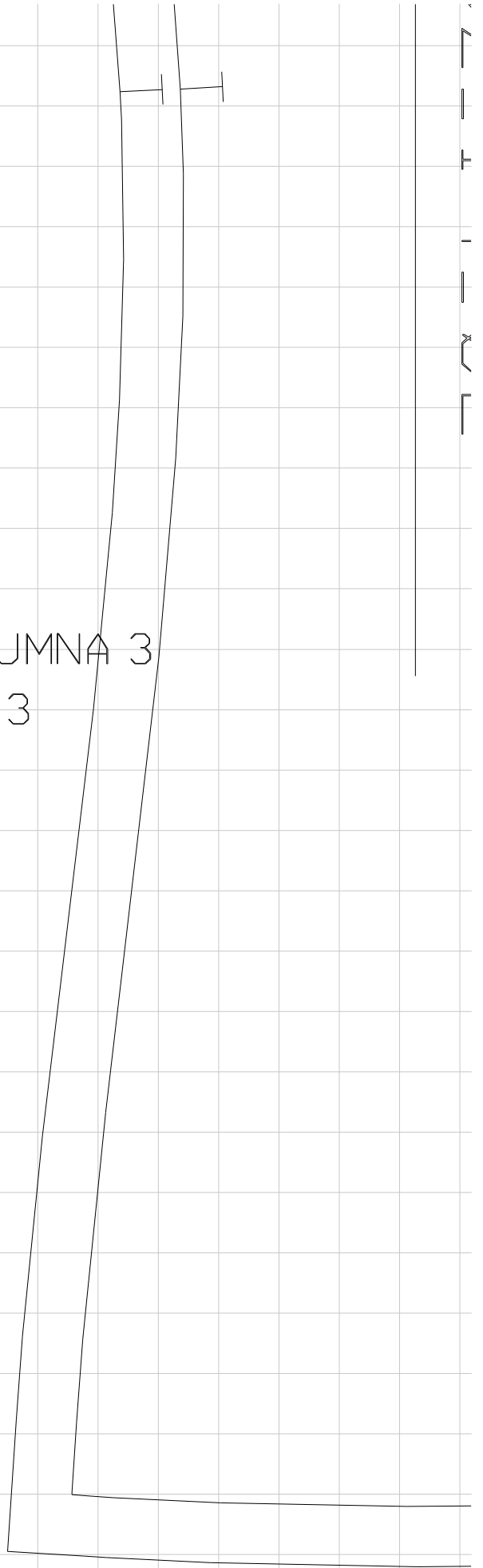

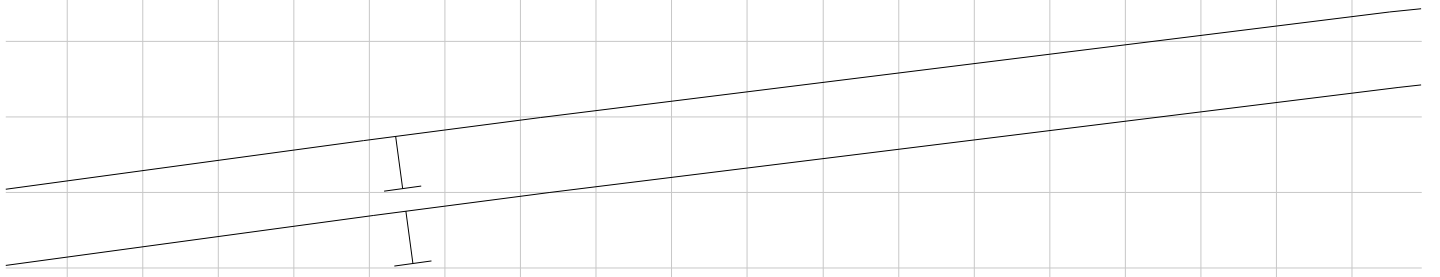

WIDOK KOLUMNA 4 PASEK / BI
ROW 1 COLUMN 4: 38

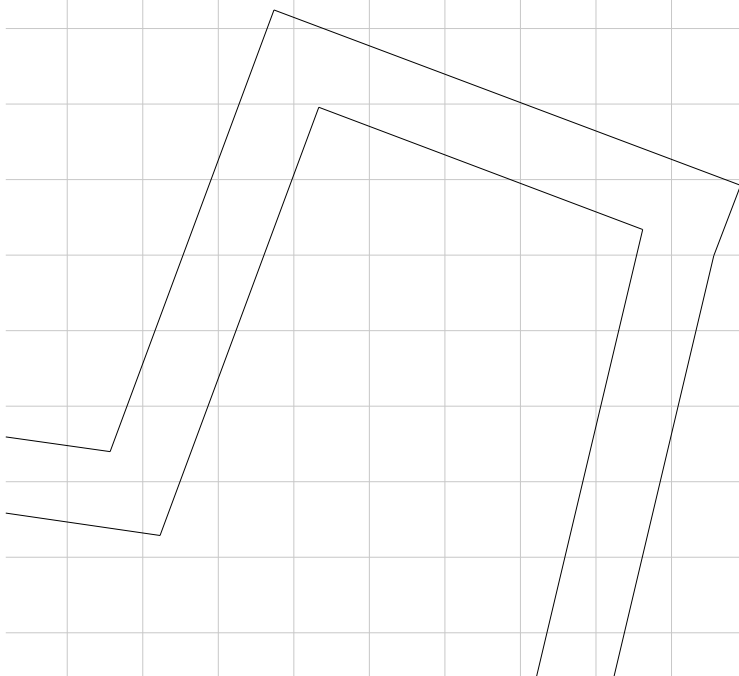
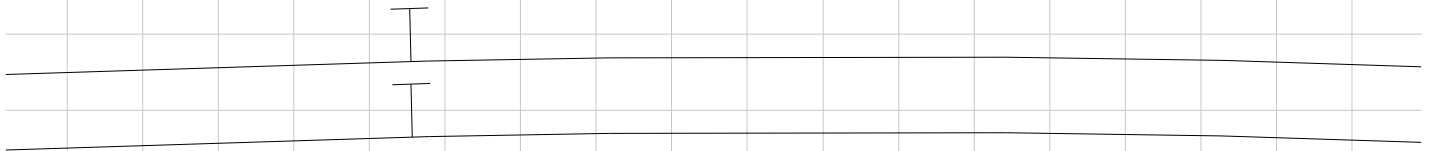

WIERSZ 2 KOLUMNA 4
ROW 2 COLUMN 4

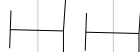

WIERSZ 3 KOLUMNA 4
ROW 3 COLUMN 4

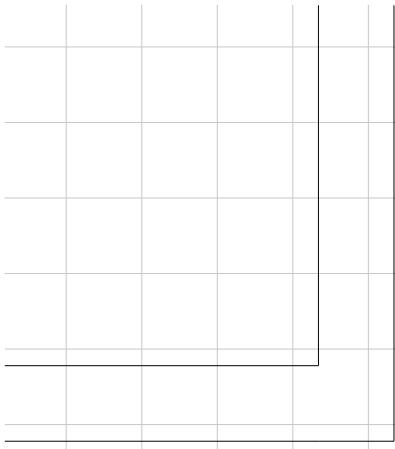

WI ERSZ 4 KOLUMNA 4
ROW 4 COLUMN 4

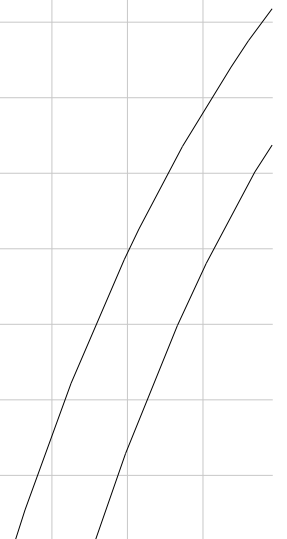
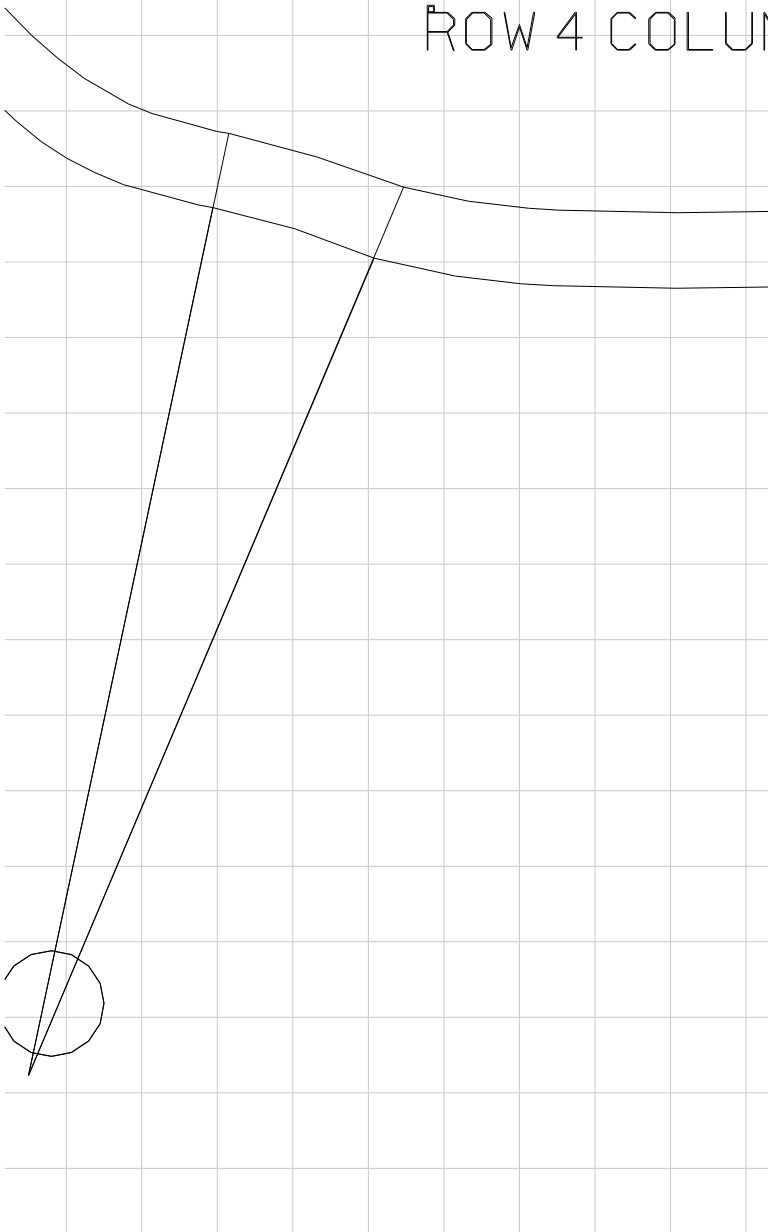

W W W W W W W W W W W W W W W W



W W W W

WIERSZ 5 KOLUMNA 4
□ ROW 5 COLUMN 4

P A P A V E

T N : 3 T Y I / R A N K W P R

Wiersz 6 Kolumna 4

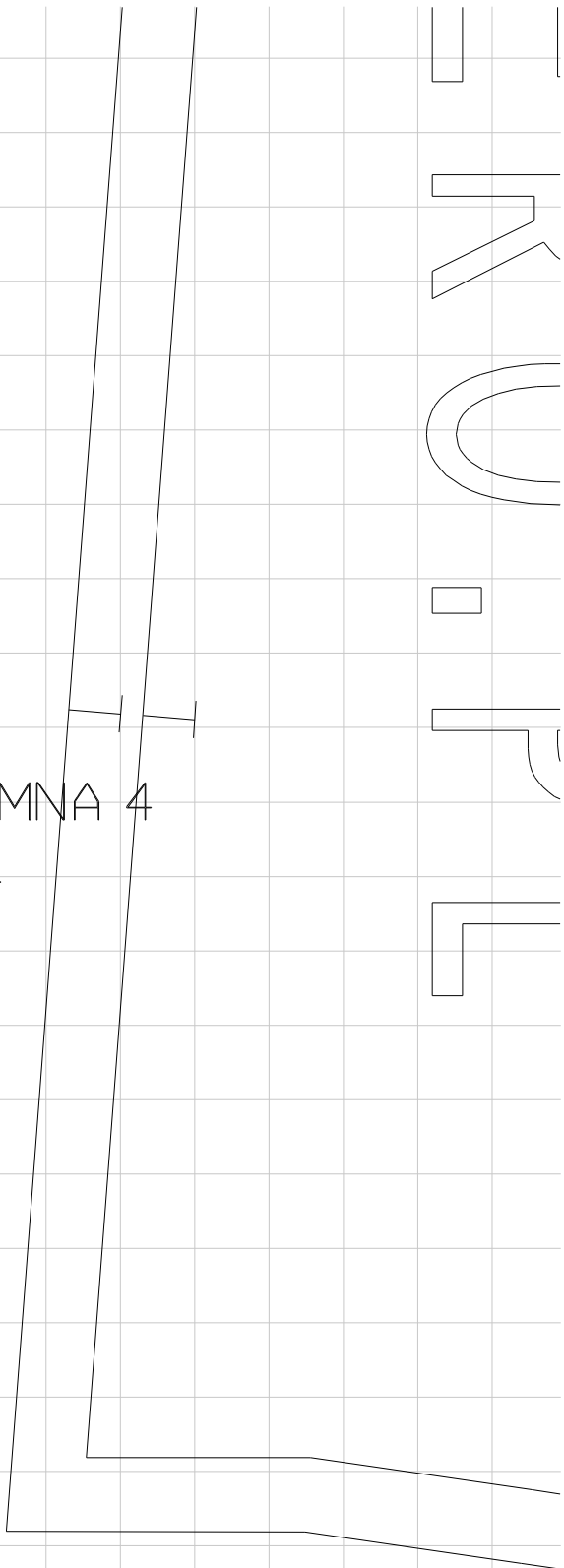

RO.P

Wiersz 6 Kolumna 4
ROW 6 COLUMN 4

7 1 4 0 2

ELT W WIERZCH 1402

ROW 1 COLUMN 5

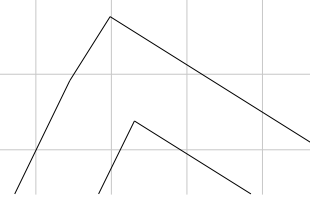

WIERSZ 2 KOLUMNA 5
ROW 2 COLUMN 5

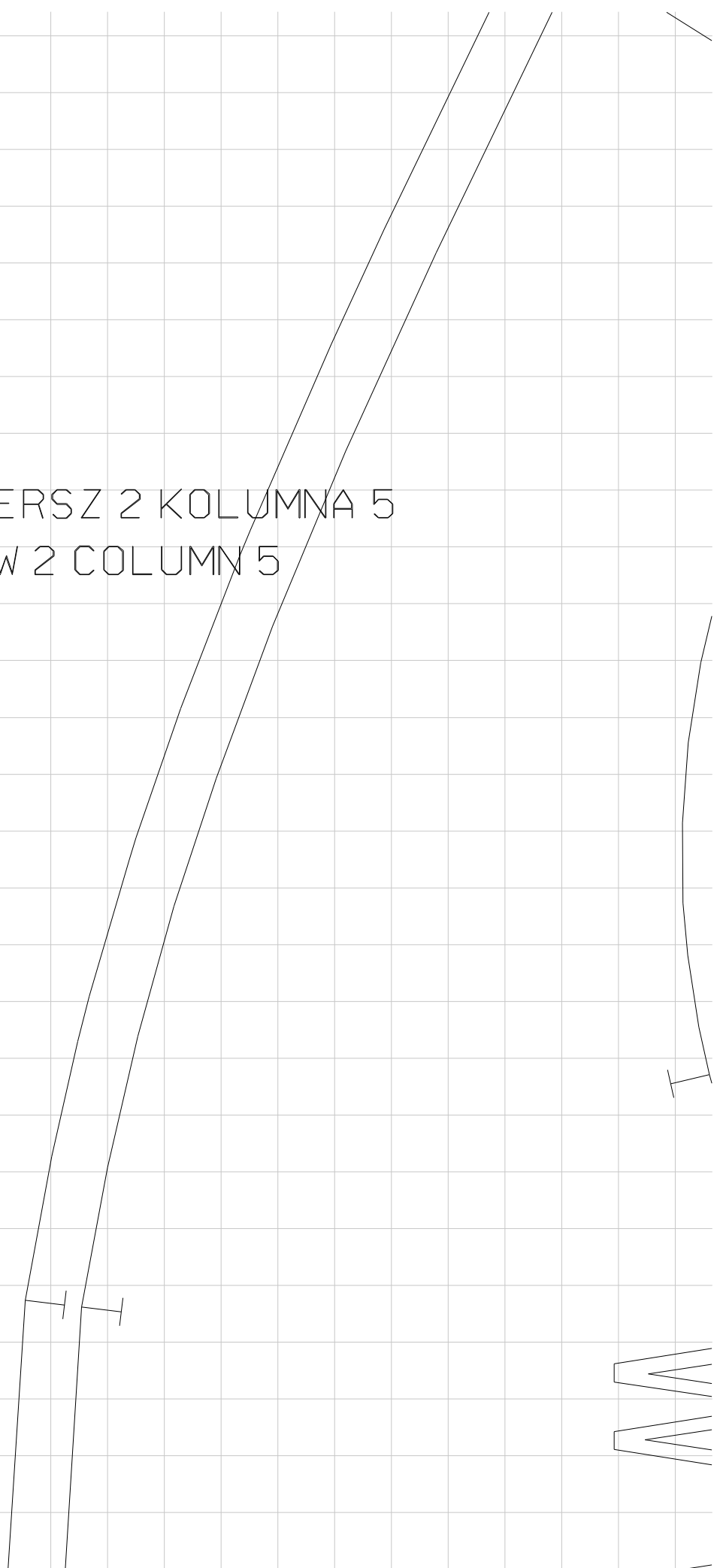

AA

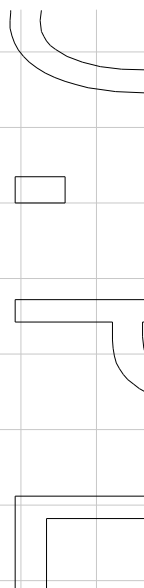
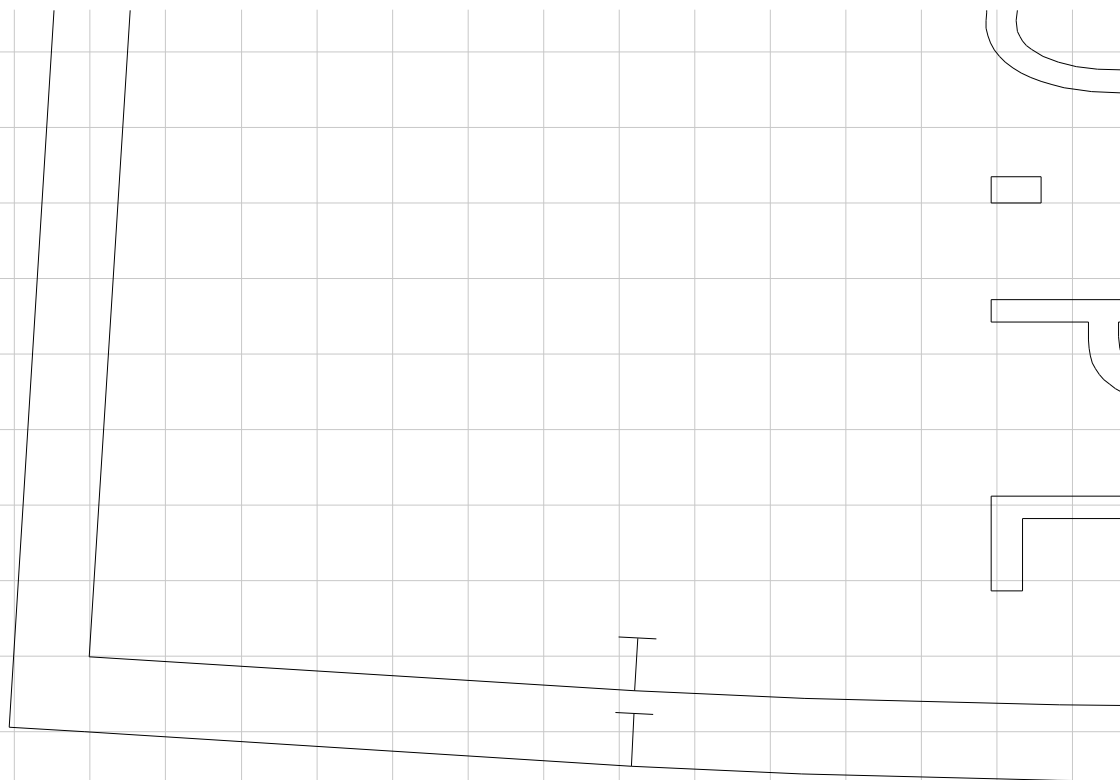

WIERSZ 4 KOLUMNA 5
ROW 4 COLUMN 5

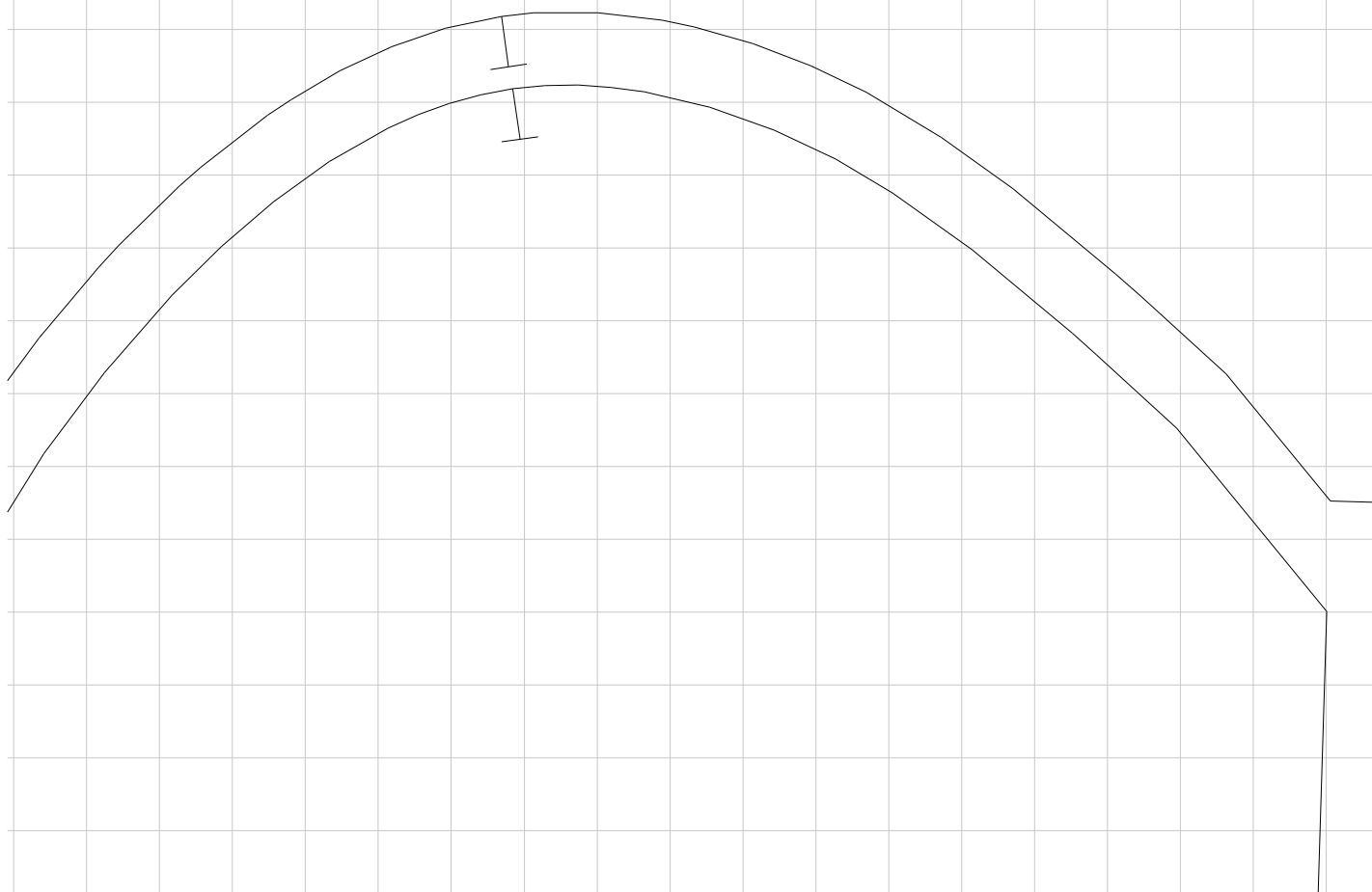

I
I

ST
WTERSZ 5 KOLUMNA 5
ROW 5 COLUMN 5
11
38
PREKAW/SLEEVE

W
W
W
W
D
A
D
A
W
I

W-PCZ-14-05

WIERSZ 6 KOLUMNA 5
ROW 6 COLUMN 5

FDPI



WI ERSZ 1 KOLUMNA 6
ROW 1 COLUMN 6

WI ERSZ 2 KOLUMNA 6
ROW 2 COLUMN 6

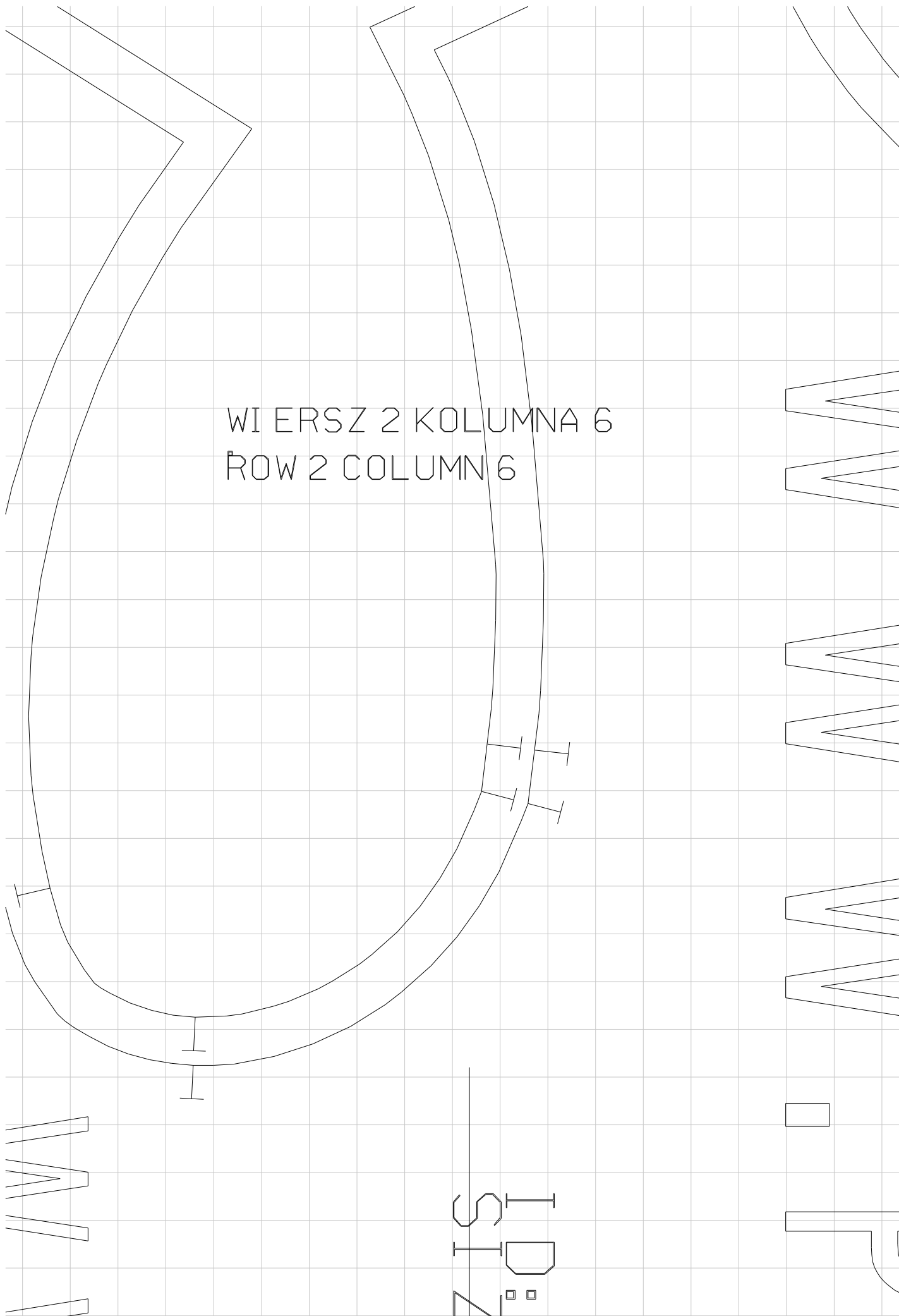

A B C D E F G H I

J PRZOD+TYL / FRONT+BACK W_PC

Ł 38

WIERSZ 3 KOLUMNA 6
ROW 3 COLUMN 6

M N O P Q R S T U V W X Y Z

Z-14-02

WIERSZ 4 KOLUMNA 6
ROW 4 COLUMN 6

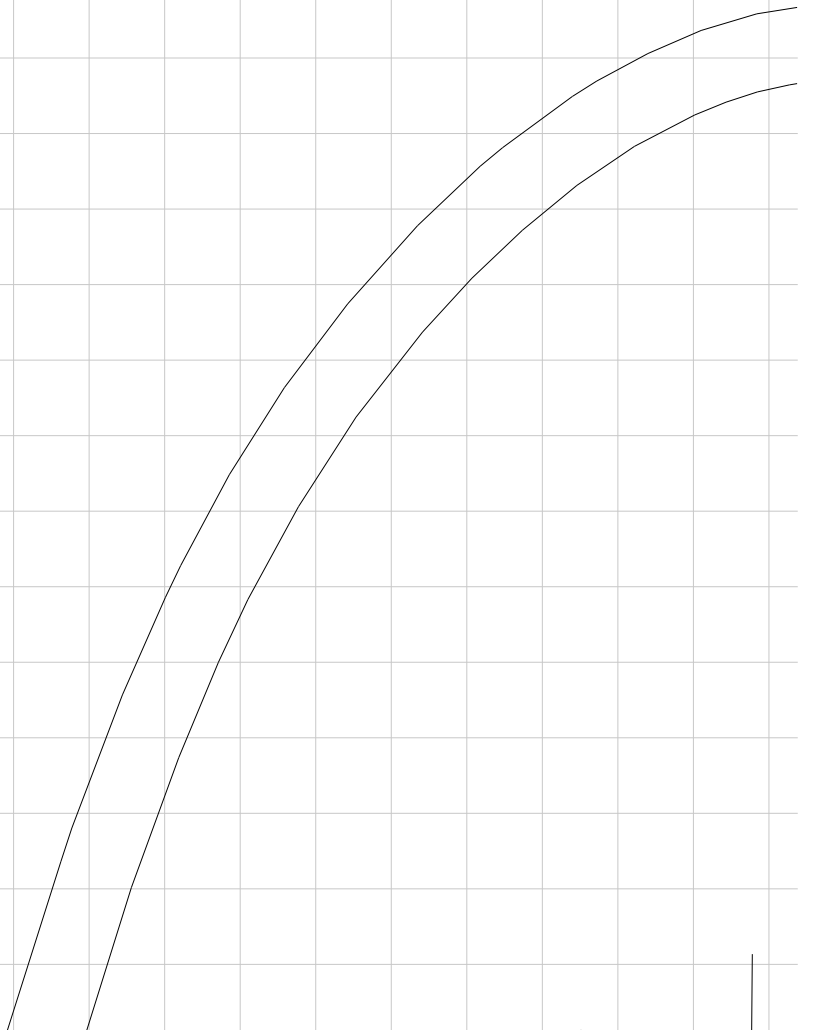
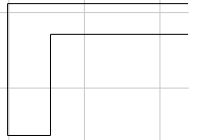
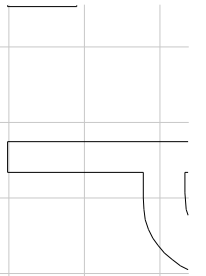
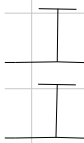
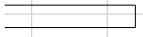
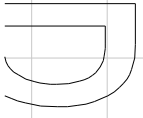

SIZE: 38

W W W W P A P A V E

WIERSZ 5 KOLUMNA 6
ROW 5 COLUMN 6

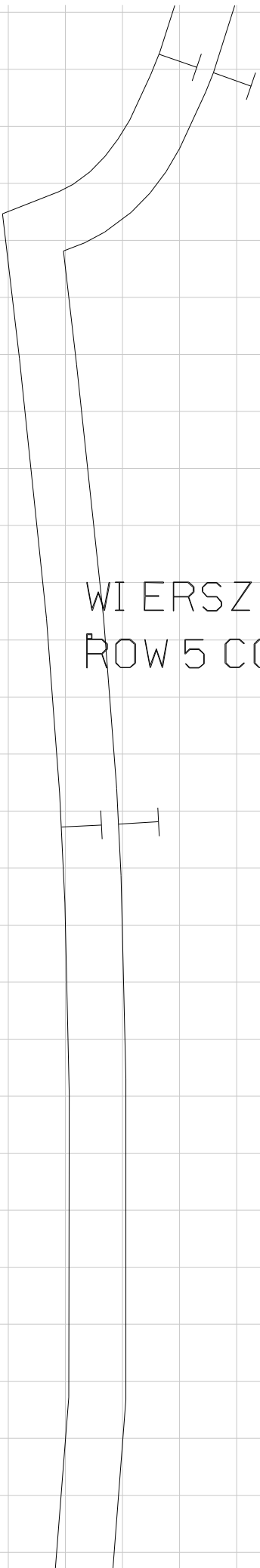

R

O

.

P

H H

WIERSZ 6 KOLUMNA 6

ROW 6 COLUMN 6

—

⌋

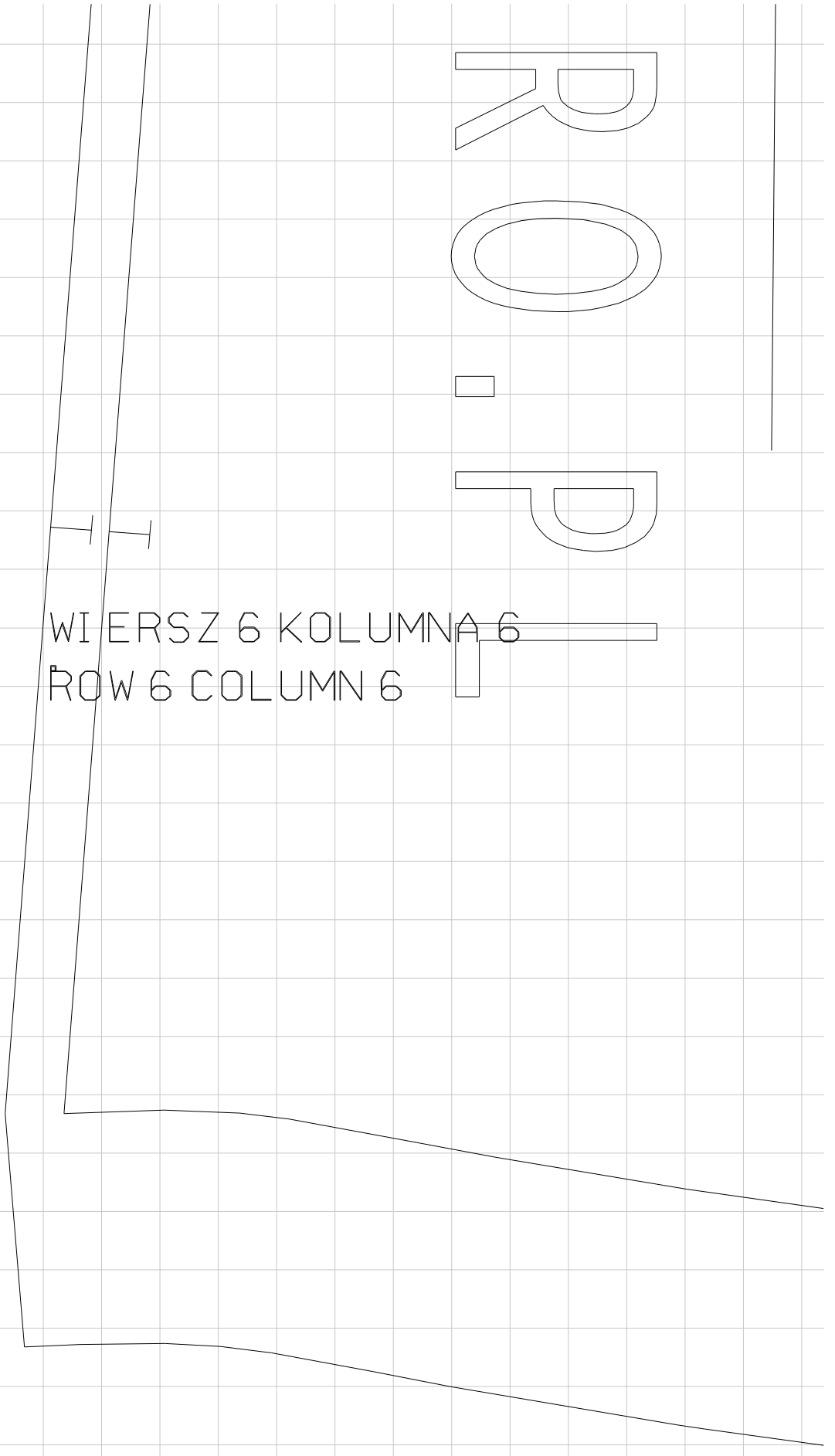



WIERSZ 1 KOLUMNA 7
ROW 1 COLUMN 7

ID: 4 KOLNIERZ/COLL
SIZE: 38

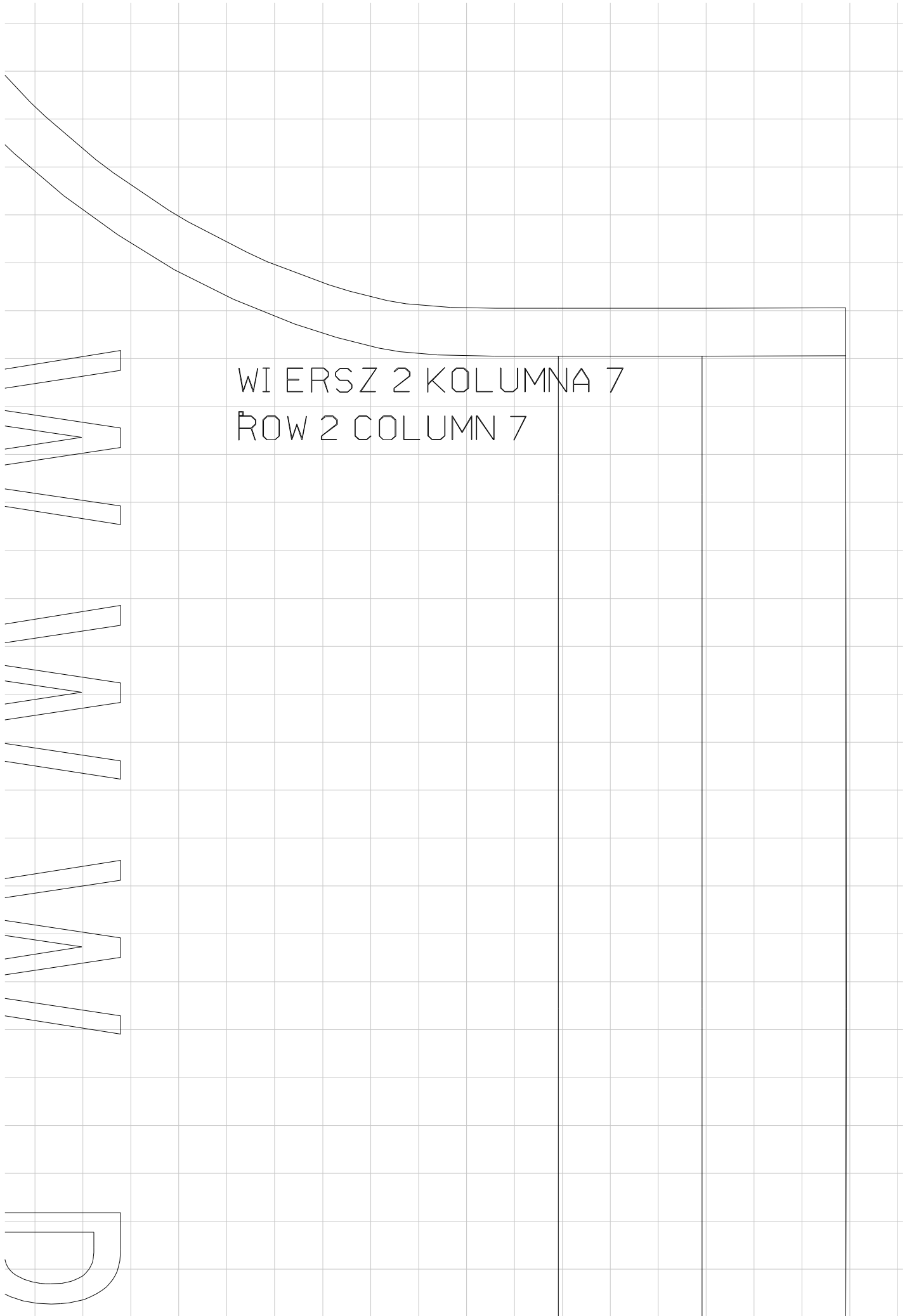

WI ERSZ 2 KOLUMNA 7
ROW 2 COLUMN 7

A

D

A

W

E

D

U

WIERSZ 3 KOLUMNA 7
ROW 3 COLUMN 7



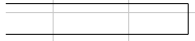
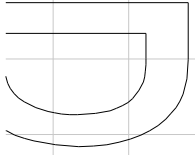

WIERSZ 4 KOLUMNA 7
ROW 4 COLUMN 7

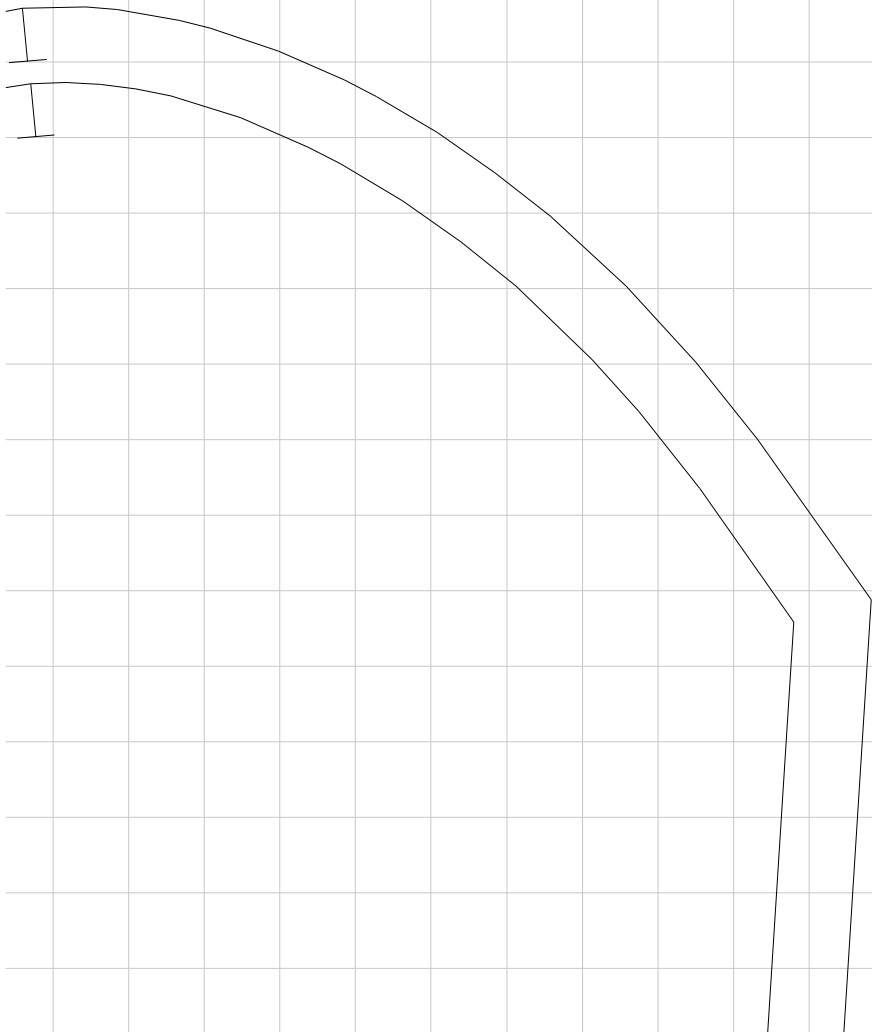

ID: 5 REKAW/SLEEVE W.

WIERSZ 5 KOLUMNA 7
ROW 5 COLUMN 7



PCZ-14-02

WIERSZ 6 KOLUMNA 7
ROW 6 COLUMN 7

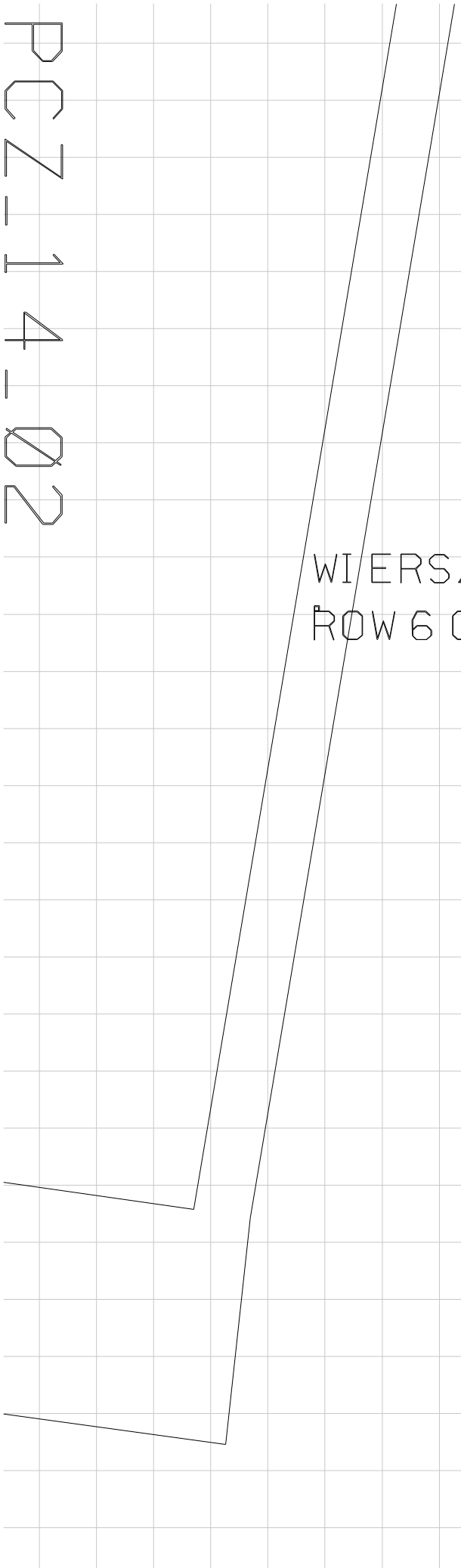

WIERSZ 1 KOLUMNA 8
ROW 1 COLUMN 8

AR W_PCZ_14_02

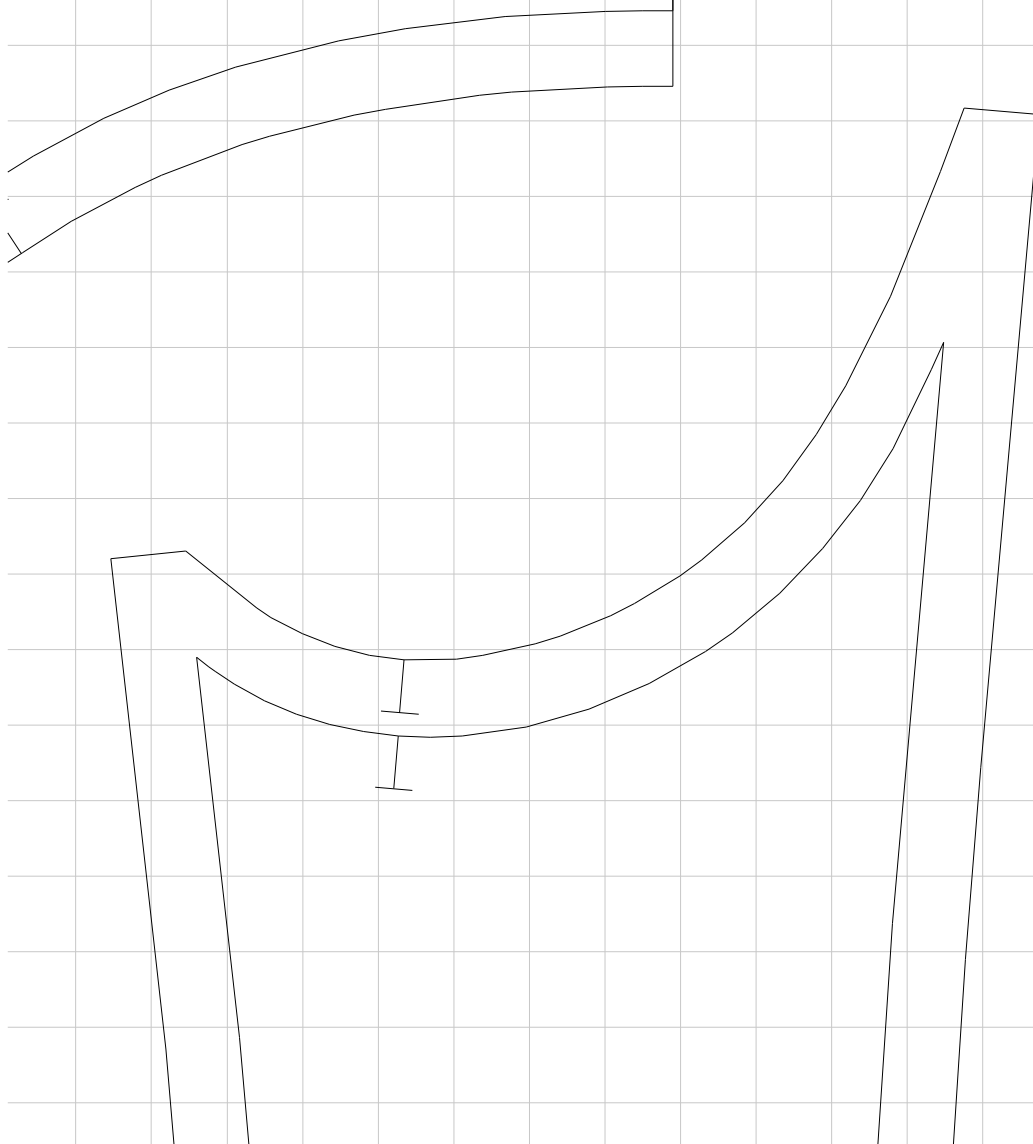

WIERSZ 2, KOLUMNA 8
ROW 2 COLUMN 8

WIELKOSC: 2 BOK / SIDE W_PCZ-

I

I

14-02

WIERSZ 3 KOLUMNA 8

ROW 3 COLUMN 8

ID: 7 TYL/BACK W_PCZ_14_02
SIZE: 38